



Aditamentos Compatibles









www.eliteabutments.com









Índice

Interfases y scanbodies Elite Abutments®	4
Réplicas digitales y librerías digitales Elite Abutments®	5
Transepiteliales Multi-Use® y Elitor®	6
Kit extractor de implantes y tornillos coronados	7
Kits llaves protésicas	8
Etiquetado y Certificaciones	10

Listado de compatibilidades

 Astra® Evolution® [Ø3.0 / Ø3.6 / Ø4.2 / Ø4.8 / Ø5.4]	12
 Astra® Osseospeed® [Ø3.0 / Ø3.5 -Ø4.0 / Ø4.5-Ø5.0]	14
 Biomet® 3i® Certain® [Ø3.4 / Ø4.10 / Ø5.0]	16
 Biomet® 3i® Osseotite® Ø3.4 / Ø4.1 / Ø5.1]	18
 Bti® Interna® [Ø4.1 / Ø5.5]	21
 Dentsply® Ankylos® C/X [Ø3.5 / Ø4.5 / Ø5.5]	23
 Megagen® Anyridge® [Ø3.5-Ø6.0]	24
 Mis® Seven® [Ø3.3 / Ø3.75 / Ø4.5]	25
 Neodent® CM [Ø3.5 / Ø4.5 / Ø5.5]	27

	Neodent® GM [Ø3.5]	28
	Nobel Biocare® Brånemark System® [Ø3.5 / Ø4.1 / Ø5.1]	29
	Nobel Biocare® Nobel Active® [Ø3.0 / Ø3.5 / Ø4.3]	32
	Nobel Replace® Select [Ø3.5 / Ø4.3 / Ø5.0]	34
	Osstem Implant® TS Implant [Ø4.0 / Ø4.5 / Ø5.5]	36
	Straumann® Bone Level [Ø3.3 / Ø4.1]	37
	Straumann® Tissue Level [Ø4.8 / Ø6.5]	39
	Componentes Sistema Synocta [Ø4.8]	41
	Sweden Y Martina® Premium Kohno® [Ø3.3 / Ø3.8 / Ø4.25]	42
	Zimmer® Screw Vent® [Ø2.9 / Ø3.5 / Ø4.5 / Ø5.7]	44
	Componentes Multi-Use® [Ø4.8 / Ø6.5]	46
	Componentes Sobredentadura Elitor®	47
	Llaves Y Herramientas	48
	Otras Conexiones Y Biomateriales	51

Interfases

Fabricadas en titanio grado 5, las interfases cementables de última generación Elite Abutments® **garantizan una unión perfecta** entre implantes y restauraciones confiriendo una **mayor estabilidad y durabilidad** en los trabajos dentales.

Su diseño con ventana lateral permite corregir angulaciones con mayor facilidad y la cara plana permite una **perfecta orientación con la conexión del implante**. El acabado anodizado garantiza los mejores resultados estéticos.

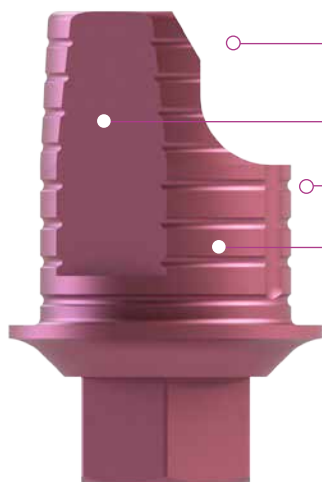

Ventana para prótesis anguladas.

Cara Plana para una perfecta orientación con la conexión del implante.

Ranuras para una perfecta cementación.

Anodizado Pink® para excelentes resultados estéticos.

Scanbody

Los nuevos scanbody están **fabricados en Titanio Grado 5 o Peek Radio Opaco** para una mayor durabilidad. El diseño con doble cara plana permite una perfecta identificación de la posición de la conexión del implante y su tratamiento superficial garantiza una imagen perfecta en RX. **El grabado láser permite una fácil identificación del producto** tanto física como virtualmente en las librerías digitales Elite Abutments®.



Fabricado en Titanio grado 5

Doble cara plana para una fácil identificación de la posición de la conexión

Radiopaco para una perfecta imagen en rx

Grabado láser para una fácil identificación del producto

Réplicas Digitales

Descubra nuestras nuevas réplicas digitales, **una revolución en precisión y calidad**. Fabricadas en titanio grado 5, garantizan una durabilidad y resistencia excepcionales. Cada réplica cuenta con marcado láser para una fácil identificación, asegurando una integración perfecta en tu flujo de trabajo. Las réplicas digitales **incluyen el tornillo diseñado específicamente para un ajuste óptimo**.



Grabado láser para una fácil identificación del producto

Fabricado en Titanio grado 5

Tornillo incluido

Librerías Digitales

Encuentre toda la información en la sección Cad-Cam que encontrará en el menú superior de nuestro sitio web www.eliteabutments.com



O escanee el siguiente código QR



Guía de instalación de las librerías

- Paso 1:** Acceda a www.eliteabutments.com y pinche en la sección CAD-CAM que encontrará en el menú superior.
- Paso 2:** Haga click en descargar librerías y rellene el formulario.
- Paso 3:** Recibirá un link de descarga en su correo electrónico. Este proceso puede tardar unos minutos.
- Paso 4:** Instale las librerías de las conexiones que necesite.



exocad

elite[®]
ABUTMENTS

Pilares Multi-Use

Descubra la versatilidad de nuestros pilares Multi-Use: una amplia gama de transepiteliales para todas las conexiones, **disponibles en versiones rectas y anguladas de 17° y 30°.**

Diseñados para la máxima precisión en la conexión del implante, estos pilares **aseguran una adaptación y funcionalidad excepcionales.** Eleve el estándar de sus restauraciones dentales con soluciones que prometen durabilidad y una estética superior.

Encuentre los componentes protésicos en la página 44, sección "Componentes Multi-Use"



Pilar Multi-Use Recto

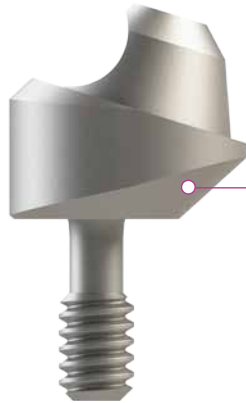

Pilar Multi-Use Angulado 17°

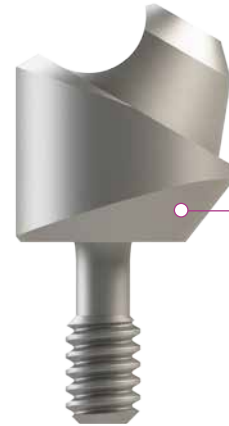

Pilar Multi-Use Angulado 30°

Pilares Elitor

Los pilares para sobredentadura Elitor están **fabricados en Titanio grado 5 y con recubrimiento en TiN,** garantizando resistencia y biocompatibilidad excepcionales. Disponibles en un gran surtido de alturas y plataformas, los pilares son **100% compatibles con el sistema Locator®.**

Nuestros Kits de Procesado le **permiten corregir divergencias entre implantes de hasta 40°** y la herramienta multi-función para los pilares Elitor le permitirá una fácil gestión de los cambios de retenedores. Todos los componentes para los pilares Elitor los encontrará en la página 45, sección "Componentes de Sobredentadura Elitor"



Recubrimiento en TiN

100% compatible con el sistema Locator®



Kit de Procesado

AU65-009KIT



Kit de Procesado Angulado

AU65-009KITANG

Extractores de Implantes Dentales y Tornillos Coronados



AU EXT-IMP KT-2

Kit de Extractores No 1, 2, 3, 4 (incluye Adaptador + Extensor + Caja)

El Kit Extractor de Implantes Dentales de **Elite Abutments®**, permite la **retirada de tornillos coronados** con la conexión de la llave deformada, así como la **extracción atraumática de implantes dentales**.

Componentes fabricados en **acero inoxidable**, almacenados en estuche esterilizable de aluminio.

Los extractores de implantes dentales se diferencian por un código numérico en la parte superior, para facilitar así su identificación.



Extractor Tornillo Coronado N.1 para Carraca Cuadrada 4x4mm

Diseñado para la retirada de tornillos con la conexión coronada. Universal para tornillos hexagonales de **1.20, 1.25, 1.27, 1.30, Unigrip, Torx**.

AU EXT-IMP-1



Extractor Tornillo Coronado N.2 para Carraca Cuadrada 4x4mm

Diseñado para la **retirada de tornillos con la conexión totalmente deteriorada**. Se utiliza cuando el extractor N°1 no sujeta o arrastra la zona afectada.

AU EXT-IMP-2



Extractor Tornillo Coronado N.3 para Carraca Cuadrada 4x4mm

Para implantes dentales de rosca **M1.6** y Carraca Cuadrada 4x4mm.

AU EXT-IMP-3



Extractor Tornillo Coronado N.4 para Carraca Cuadrada 4x4mm

Para implantes dentales de rosca **M1.8 i M2.0** Carraca Cuadrada 4x4mm.

AU EXT-IMP-4



Extensor para Carraca Cuadrada 4x4mm

Se utiliza junto al adaptador de llave para el posicionamiento manual.

AU59-100195



Adaptador Llave Carraca Cuadrada 4x4mm

Se utiliza junto al extensor de carraca para el posicionamiento manual.

AU59-100191

Instrucciones de Uso

Paso 1

Introducir manualmente el extractor recto y alineado con el implante y enroscar en el sentido contrario a las agujas del reloj para posicionar.

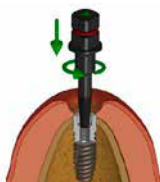

Paso 2

Ensamblar la carraca al extractor, y enroscar hacia la izquierda en sentido contrario a las agujas del reloj.

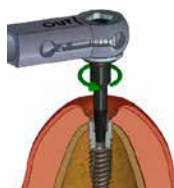

Paso 3

Cuando el extractor esté anclado a la rosca del implante dental, este se irá desenroscando de forma progresiva.



Elementos de los Kits de Llaves de Contra-Ángulo

LLAVES DE MOTOR CONTRA-ÁNGULO

- Equilibradas en términos de funcionalidad y robustez, con una elevada resistencia al desgaste, la deformación y la corrosión.
- Fabricadas en acero inoxidable de alto rendimiento con un tratamiento antidesgaste de 55 HRC para alargar la vida útil de la llave.
- Acabado estético en gris metalizado.



Variedad de puntas para las conexiones de tornillo más utilizadas del mercado.

- 1 Puntas grabadas para identificación rápida de su función.
- 2 Geometría para absorber micro-deformaciones por torque y evitar clavado en contra-ángulo.
- 3 Tolerancias de medida diezmilésimal en la conexión para garantizar la retención.
- 4 Caña esvelta, resistente y con longitud estudiada para su perfecta inserción en los canales internos de las prótesis.
- 5 Combinación de zona recta y zona cónica en todas las caras para el mejor equilibrio entre retención y resistencia a la deformación.

ADAPTADOR MULTIFUNCIONAL PARA USO DIRECTO A CARRACA O LLAVE MANUAL

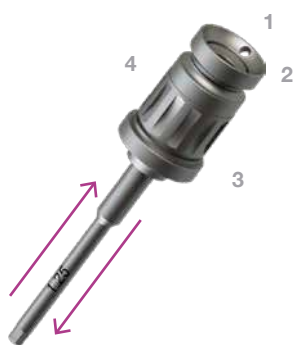

- 1 Orificio para pasar el hilo de seguridad y evitar el desprendimiento de la llave dentro de la boca del paciente.
- 2 Corona giratoria estudiada para optimizar la ergonomía de trabajo.
- 3 Moleteado central bifuncional como ajuste preciso a carraca y para evitar deslizamientos en el uso manual.
- 4 Disponible en Ø 7 compatible STRAUMANN y Ø 8 compatible NOBEL BIOCARE.

Inserción con ajuste retentivo



Perfecta y ajustada adaptación en el contra-ángulo, con longitud mínima estudiada para las llaves cortas.



Perfecta y ajustada adaptación en el contra-ángulo, con longitud mínima estudiada para las llaves cortas.



Perfecta y ajustada adaptación en el contra-ángulo, con longitud mínima estudiada para las llaves cortas.

ENVASE

- Inserción directa de las llaves al adaptador desde el propio envase.
- Envase esterilizable en autoclave y de almacenaje óptimo, tanto de llaves cortas como largas.
- Grabado de la ubicación de cada llave para facilitar la identificación rápida.
- Envase diferenciado para llaves cortas y largas a través del color de su base.
- 2 ubicaciones libres para colocación de llaves especiales no incorporadas en el kit.













Llaves Cortas: AU58-100001



Llaves Largas: AU58-100002

Detalle color diferencial para llaves cortas (azul) y llaves largas (rojo).

Contenido del kit de llaves contra-ángulo cortas

AU59-100198	Adaptador para llave de Contra-Ángulo a carraca de Ø 7.0 mm	
AU58-100205-S	Llave Para Contra-Ángulo Corta HEX. 0.90	
AU58-100130	Llave Para Contra-Ángulo Corta HEX. 1.20	
AU58-100120	Llave Para Contra-Ángulo Corta HEX. 1.25	
AU58-100117	Llave Para Contra-Ángulo Corta HEX. 1.27	
AU58-100185	Llave Para Contra-Ángulo Corta HEX. 1.70	
AU58-100174	Llave Para Contra-Ángulo Corta TORX	
AU58-100178	Llave Para Contra-Ángulo Corta UNIGRIP	
AU58-100300	Llave para Contra-Ángulo Corta Angled Grip	
AU58-100160	"Llave Motor Contra-Ángulo Multi-Unit Hex.2"	
AU58-100146	Llave Motor Contra-Ángulo Locator Corta	

Contenido del kit de llaves contra-ángulo largas

AU59-100198	Adaptador para llave de Contra-Ángulo a carraca de Ø 7.0 mm	
AU58-100205	Llave Para Contra-Ángulo Larga HEX. 0.90	
AU58-100111-M	Llave Para Contra-Ángulo Larga HEX. 1	
AU58-100135	Llave Para Contra-Ángulo Larga HEX. 1.20	
AU58-100125	Llave Para Contra-Ángulo Larga HEX. 1.25	
AU58-100118	Llave Para Contra-Ángulo Larga HEX. 1.27	
AU58-100186	Llave Para Contra-Ángulo Larga HEX. 1.70	
AU58-100174-M	Llave Para Contra-Ángulo Larga TORX	
AU58-100178-M	Llave Para Contra-Ángulo Larga UNIGRIP	
AU58-100133-M	Llave Para Contra-Ángulo Larga Cuadrada 1.30	
AU58-100300-M	Llave para Contra-Ángulo Larga Angled Grip	

Etiquetado

Etiquetado de productos normativa MDR 2017/745

1. Descripción de la conexión
2. Descripción del producto
3. Referencia del producto
4. Número de lote
5. Símbolo que indica que las instrucciones de uso contienen advertencias
6. Símbolo de que el producto está destinado a un solo uso.
7. Símbolo que indica que el producto no se puede reesterilizar.
8. Símbolo "Consultar Instrucciones de uso".
9. Símbolo que identifica el producto como no estéril.
10. Este símbolo solo se aplica a modelos de productos que tienen cobalto en su composición (TCSC)
11. Marcado CE con número de organismo Notificado
12. Símbolo que identifica el producto como dispositivo médico.
13. Símbolo "Mantener alejado de la luz solar"
14. Símbolo "Mantener seco".
15. Fecha de fabricación
16. Código UDI de identificación de producto sanitario.
(01) UDI-DI del producto
(10) Fecha de fabricación.
(11) N° de lote.
17. Código QR que dirige al sitio web donde están alojadas las "Instrucciones de Uso".
18. Datos completos del fabricante.



Certificaciones



ISO 9001:2015



ISO 13485:2016



Certificado CE

Catálogo General

CONEXIONES COMPATIBLES





Astra® Evolution®

Plataformas:

Ø3.00 / Ø3.60 / Ø4.20 / Ø4.80 / Ø5.40

Conexión Tornillo Clínico:



Hexagonal 1.27

Compatible con:

Astra® Evolution®

Pilar Cicatrización Torque máx: 20 Ncm



	Ø3.60	Ø4.20	Ø4.80
Perfil Emergencia	Ø4.50	Ø5.50	Ø6.50
			
H 2.0 mm	AU20-362120-45	AU20-422120-55	AU20-482120-65
H 4.0 mm	AU20-362140-45	AU20-422140-55	AU20-482140-65
H 6.0 mm	AU20-362160-45	AU20-422160-55	-

Coping Impresión



Réplica



	Ø3.60	Ø4.20	Ø4.80
Cubeta Abierta	AU20-360090	AU20-420090	AU20-480090



	Ø3.00	Ø3.60	Ø4.20	Ø4.80	Ø5.40
	AU20-300015	AU20-360015	AU20-420015	AU20-480015	AU20-540015



Tornillo Clínico Torque máx:25 Ncm



Pilar Provisional



	Ø3.00	Ø3.60	Ø4.20	Ø4.80 - Ø5.40
Hex. 1.27	M1.4	M1.6	M1.8	M2
Normal	AU20-300056	AU20-360056	AU20-420056	AU20-480056



	Ø3.60	Ø4.20	Ø4.80
Antirrotatorio	AU20-360300	AU20-420300	AU20-480300
Rotatorio	AU20-360350	AU20-420350	AU20-480350



Ver herramientas en la página 48

Tornillo no incluido en el envase

Calcinable con Base Cr-Co



Calcinable (POM C)



	Ø3.60	Ø4.20	Ø4.80
Antirrotatorio	AU20-360400	AU20-420400	AU20-480400
Rotatorio	AU20-360450	AU20-420450	AU20-480450



	Ø3.00	Ø3.60	Ø4.20	Ø4.80	Ø5.40
Antirrotatorio	AU20-300200	AU20-360200	AU20-420200	AU20-480200	AU20-540200
Rotatorio	-	AU20-360250	AU20-420250	AU20-480250	AU20-540250



Tornillo no incluido en el envase

Tornillo no incluido en el envase

Pilar Multi-Use Recto Torque m ax: 30 Ncm

	Ø3.60	Ø4.20	Ø4.80
H 1.5 mm	AU20-361015	AU20-421015	AU20-481015
H 2.5 mm	AU20-361025	AU20-421025	AU20-481025
H 3.5 mm	AU20-361035	AU20-421035	AU20-481035
H 4.5 mm	AU20-361045	AU20-421045	AU20-481045
H 5.5 mm	AU20-361055	AU20-421055	AU20-481055



Ver componentes Multi-Use en la p gina 46

Pilar Multi-Use Angulado Torque m ax: 30 Ncm

	Ø3.60	Ø4.20	Ø4.80	
17°	H 2.5 mm	AU20-361217-25	AU20-421217-25	AU20-481217-25
	H 3.5 mm	AU20-361217-35	AU20-421217-35	AU20-481217-35
30°	H 3.5 mm	AU20-361230-35	AU20-421230-35	AU20-481230-35
	H 4.5 mm	AU20-361230-45	AU20-421230-45	AU20-481230-45



Ver componentes Multi-Use en la p gina 46

Pilar Elitor Recto Torque m ax: 30 Ncm

	Ø3.60	Ø4.20	Ø4.80
H 1.0 mm	AU65-AEV361	AU65-AEV421	AU65-AEV481
H 2.0 mm	AU65-AEV362	AU65-AEV422	AU65-AEV482
H 3.0 mm	AU65-AEV363	AU65-AEV423	AU65-AEV483
H 4.0 mm	AU65-AEV364	AU65-AEV424	AU65-AEV484
H 5.0 mm	AU65-AEV365	AU65-AEV425	AU65-AEV485



Ver componentes Elitor en la p gina 47



Astra® Osseospeed®

Plataformas:

Ø3.0 YELLOW / Ø3.5 / Ø4.0 AQUA / Ø4.5 / Ø5.0 LILAC

Conexión Tornillo Clínico:

Hexagonal 1.27

Compatible con:

Astra® Osseospeed®

Pilar Cicatrización Torque máx: 20 Ncm



	Ø3.0 Yellow	Ø3.5 / Ø4.0 Aqua			Ø4.5 / Ø5.0 Lilac	
Perfil Emergencia	Ø3.6	Ø4.50	Ø5.50	Ø5.50	Ø5.65	
H 2.0 mm	AU30-302120	AU30-352120-D45	AU30-352120-D55	AU30-452120-D55	AU30-452120-D65	
H 4.0 mm	AU30-302140	AU30-352140-D45	AU30-352140-D55	AU30-452140-D55	AU30-452140-D65	
H 6.0 mm	AU30-302160	AU30-352160-D45	AU30-352160-D55	AU30-452160-D55	AU30-452160-D65	

Coping Impresión



	Ø3.0 Yellow	Ø3.5/Ø4.0 Aqua	Ø4.5/Ø5.0 Lilac
Cubeta Abierta	AU30-300090	AU30-350090	AU30-450090
Cubeta Cerrada	-	-	-



Réplica



	Ø3.0 Yellow	Ø3.5/Ø4.0 Aqua	Ø4.5/Ø5.0 Lilac
12 Posiciones	AU30-300015	AU30-350015	AU30-450015
6 Posiciones	-	AU30-350016	-



Tornillo Clínico Torque máx: 25 Ncm



	Ø3.0 Yellow	Ø3.5/Ø4.0 Aqua	Ø4.5/Ø5.0 Lilac
Hex. 1.27	M1.4	M1.6	M2
Normal	AU30-300052	AU30-350052	AU30-450052
DLC	-	AU30-350052-N	AU30-450052-N



Ver herramientas en la página 48

Pilar Provisional



	Ø3.0 Yellow	Ø3.5/Ø4.0 Aqua	Ø4.5/Ø5.0 Lilac
Antirrotatorio	-	AU30-350300	AU30-450300
Rotatorio	-	AU30-350350	AU30-450350



Tornillo no incluido en el envase

Calcinable con Base Cr-Co



	Ø3.0 Yellow	Ø3.5/Ø4.0 Aqua	Ø4.5/Ø5.0 Lilac
Antirrotatorio	-	AU30-350400	AU30-450400
Rotatorio	-	AU30-350450	AU30-450450



Tornillo no incluido en el envase

Calcinable (POM C)



	Ø3.0 Yellow	Ø3.5/Ø4.0 Aqua	Ø4.5/Ø5.0 Lilac
Antirrotatorio	AU30-300200	AU30-350200	AU30-450200
Rotatorio	-	AU30-350250	AU30-450250



Tornillo no incluido en el envase

Pilar Cementable Recto



		Ø3.5/Ø4.0 Aqua	Ø4.5/Ø5.0 Lilac
Antirrotatorio	H 0.0 mm	AU30-351320	-
	H 1.0 mm	AU30-351321	-
	H 2.0 mm	-	AU30-451320
	H 3.0 mm	AU30-351323	-
	H 4.0 mm	AU30-351325	-
Rotatorio	H 0.0 mm	AU30-351330	-



Tornillo no incluido en el envase

Pilar Elitor Recto Torque máx: 30 Ncm



	Ø3.0 Yellow	Ø3.5/Ø4.0 Aqua	Ø4.5/Ø5.0 Lilac
H 1.0 mm	-	AU65-AS351	AU65-AS451
H 2.0 mm	-	AU65-AS352	AU65-AS452
H 3.0 mm	-	AU65-AS353	AU65-AS453
H 4.0 mm	-	AU65-AS354	AU65-AS454
H 5.0 mm	-	AU65-AS355	AU65-AS455
H 6.0 mm	-	AU65-AS356	AU65-AS456



Ver componentes Elitor en la página 47

Pilar Multi-Use Recto Torque máx: 30 Ncm



	Ø3.0 Yellow	Ø3.5/Ø4.0 Aqua	Ø4.5/Ø5.0 Lilac
H 1.5 mm	-	AU30-351015	AU30-451015
H 2.5 mm	-	AU30-351025	AU30-451025
H 3.5 mm	-	AU30-351035	AU30-451035
H 4.5 mm	-	AU30-351045	AU30-451045



Ver componentes Multi-Use en la página 46

Pilar Multi-Use Angulado Torque máx: 30 Ncm



		Ø3.5/Ø4.0 Aqua	Ø4.5/Ø5.0 Lilac
17°	H 2.5 mm	AU30-351217	AU30-451217
	H 3.5 mm	AU30-351217-35	AU30-451217-35
	H 4.0 mm	-	-
30°	H 3.5 mm	AU30-351230-35	AU30-451230
	H 4.5 mm	AU30-351230-45	AU30-451230-45
	H 6.0 mm	-	-



Ver componentes Multi-Use en la página 46

Tornillo Clínico Angulable Torque máx: 25 Ncm



	Ø3.0 Yellow	Ø3.5/Ø4.0 Aqua	Ø4.5/Ø5.0 Lilac
Conexión		M1.6	M2
Tetralobular	-	AU30-350050	AU30-450050
Angled Grip®	-	AU30-350060	AU30-450060



Ver herramientas en la página 48

Scanbody



	Ø3.0 Yellow	Ø3.5/Ø4.0 Aqua	Ø4.5/Ø5.0 Lilac
-		AU30-352201	AU30-452201



Tornillo no incluido en el envase

Réplica Digital



	Ø3.0 Yellow	Ø3.5/Ø4.0 Aqua	Ø4.5/Ø5.0 Lilac
-		AU30-350010	AU30-450010



Base Cr-Co Angulable



	Ø3.0 Yellow	Ø3.5/Ø4.0 Aqua	Ø4.5/Ø5.0 Lilac
Antirrotatorio	-	AU30-350410	AU30-450410
Rotatorio	-	AU30-350460	AU30-450460



Tornillo no incluido en el envase.

Chimenea Calcinable Angulada



	Ø3.5/Ø4.0 Aqua	Ø4.5/Ø5.0 Lilac
17°	AU67-001701	AU67-001701
30°	AU67-003001	AU67-003001



Interfases Angulables



		Ø3.5/Ø4.0 Aqua	Ø4.5/Ø5.0 Lilac
Antirrotatorio	H 1.5 mm	AU30-350600-15	AU30-450600-15
Rotatorio	H 1.5 mm	AU30-350650-15	AU30-450600-15



Tornillo no incluido en el envase



Biomet® 3i® Certain®

Plataforma:

NP Ø3.40 / RP Ø4.10 / WP Ø5.00

Conexión Tornillo Clínico:

Hexagonal 1.20

Compatible con:

Biomet 3i® Certain® y otros.

Pilar Cicatrización Torque máx: 20 Ncm



Perfil Emergencia	RP Ø4.10
	Ø5.00



H 2.0 mm	AU14-412120-D50
H 3.0 mm	AU14-412130-D50
H 4.0 mm	AU14-412140-D50
H 6.0 mm	AU14-412160-D50

Réplica



NP Ø3.40	RP Ø4.10	WP Ø5.00
AU14-340015	AU14-410015	AU14-500015



Coping Impresión



	NP Ø3.40	RP Ø4.10	WP Ø5.00
Cubeta Abierta	AU14-340090	AU14-410090	AU14-500090



Tornillo Clínico Torque máx: 25 Ncm



		NP Ø3.40	RP Ø4.10	WP Ø5.00
Hex. 1.20		M1.6	M1.6	M1.6
Aditamentos Rotatorios	Normal	AU14-340052	AU14-410052	AU14-410052
	DLC	AU14-340052-N	AU14-410052-N	AU14-410052-N
Aditamentos Antirrotatorios	Normal	AU14-340052	AU14-340052	AU14-340052
	DLC	AU14-340052-N	AU14-340052-N	AU14-340052-N



Pilar Provisional Torque máx: 30 Ncm



	NP Ø3.40	RP Ø4.10	WP Ø5.00
Antirrotatorio	AU14-340300	AU14-410300	AU14-500300
Rotatorio	AU14-340350	AU14-410350	AU14-500350



Tornillo no incluido en el envase

Ver herramientas en la página 48

Calcinable con Base Cr-Co



	Ø3.40	Ø4.10	Ø5.00
Antirrotatorio	AU14-340400	AU14-410400	AU14-500400
Rotatorio	AU14-340450	AU14-410450	AU14-500450



Tornillo no incluido en el envase

Calcinable (POM C)



	Ø3.40	Ø4.10	Ø5.00
Antirrotatorio	AU14-340200	AU14-410200	AU14-500200
Rotatorio	AU14-340250	AU14-410250	AU14-500250



Tornillo no incluido en el envase

Pilar Multi-Use Recto Torque m ax: 30 Ncm



	NP �3.40	RP �4.10	WP �5.00
H 1.0 mm	AU14-341010	AU14-411010	AU14-501010
H 2.0 mm	AU14-341020	AU14-411020	AU14-501020
H 3.0 mm	AU14-341030	AU14-411030	AU14-501030
H 4.0 mm	AU14-341040	AU14-411040	AU14-501040



Ver componentes Multi-Use en la p gina 46

Pilar Multi-Use Angulado Torque m ax: 30 Ncm



	NP �3.40	RP �4.10	WP �5.00	
17�	H 2.0 mm	AU14-341217-2	AU14-411217-2	AU14-501217-2
	H 4.0 mm	AU14-341217-4	AU14-411217-4	AU14-501217-4
30�	H 3.0 mm	AU14-341230-3	AU14-411230-3	AU14-501230-3
	H 5.0 mm	AU14-341230-5	AU14-411230-5	AU14-501230-5



Ver componentes Multi-Use en la p gina 46

Pilar Elitor Recto Torque m ax: 30 Ncm



	NP �3.40	RP �4.10
H 1.0 mm	AU65-00CE341	AU65-00CE401
H 2.0 mm	AU65-00CE342	AU65-00CE402
H 3.0 mm	AU65-00CE343	AU65-00CE403
H 4.0 mm	AU65-00CE344	AU65-00CE404
H 5.0 mm	AU65-00CE345	AU65-00CE405
H 6.0 mm	AU65-00CE346	AU65-00CE406



Tornillo C nico Angulable Torque m ax: 25 Ncm



	NP �3.40	RP �4.10	WP �5.00
Conexi�n	M1.6	M1.6	M1.6
Tetralobular	AU14-340050	AU14-340050	AU14-340050



Ver herramientas en la p gina 48

Chimenea Calcinable Angulada



	NP �3.40	RP �4.10	WP �5.00
17�	AU67-001701	AU67-001701	-
30�	AU67-003001	AU67-003001	-



Base Cr-Co Angulable



	NP �3.40	RP �4.10	WP �5.00
Antirrotatorio	AU14-340410	AU14-410410	AU14-500410
Rotatorio	AU14-340460	AU14-410460	AU14-500460



Tornillo no incluido en el envase.

Interfases Angulables



	NP �3.40	RP �4.10	WP �5.00	
Antirrotatorio	H 0.5 mm	AU14-340600-05	AU14-410600-05	AU14-500600-05
Rotatorio	H 0.5 mm	AU14-340650-05	AU14-410650-05	AU14-500650-05



Tornillo no incluido en el envase

Scanbody



NP �3.40	RP �4.10	WP �5.00
AU14-342201	AU14-412201	AU14-502201



Tornillo no incluido en el envase

R plica Digital



NP �3.40	RP �4.10	WP �5.00
AU14-340010	AU14-410010	AU14-500010



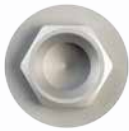

Biomet® 3i® Osseotite®

Plataformas:

RP Ø4.1 / WP Ø5.1

Conexión Tornillo Clínico:



Unigrip® / Hexagonal 1.20 / Hexagonal 1.25 / Cuadrada 1.30

Compatible con:

Biomet 3i Osseotite Tapered

Pilar Cicatrización Torque máx: 20 Ncm



Perfil Emergencia	RP Ø4.10		WP Ø5.10
	Ø4.10	Ø5.50	Ø6.0
H 2.0 mm	 AU44-002120	 AU44-002120-50	-
H 3.0 mm	AU44-002130	AU44-002130-50	AU51-502130
H 4.0 mm	AU44-002140	AU44-002140-50	-
H 5.0 mm	AU44-002150	AU44-002150-50	AU51-502150

Coping Impresión



Réplica



	RP Ø4.10	WP Ø5.10
Cubeta Abierta	AU44-000090	AU51-500090
Cubeta Cerrada	AU44-000080	-



	RP Ø4.10	WP Ø5.10
	AU44-000015	AU51-500015



Tornillo Clínico Torque máx:25 Ncm



	RP Ø4.10	WP Ø5.10
Unigrip	M2	M2
Normal	AU44-E00057	AU44-E00057
DLC	AU44-E00057-N	AU44-E00057-N
Hexagonal 1.20	M2	M2
Normal	AU44-E00054	AU44-E00054
DLC	AU44-E00054-N	AU44-E00054-N

	RP Ø4.10	WP Ø5.10
Hexagonal 1.25	M2	M2
Normal	AU44-E00052	AU44-E00052
DLC	AU44-E00052-N	AU44-E00052-N
Cuadrada 1.30	M2	M2
Normal	AU44-E00053	AU44-E00053
DLC	AU44-E00053-N	AU44-E00053-N



Ver herramientas en la página 48

Calcinable con Base Cr-Co



	RP Ø4.10	WP Ø5.10
Antirrotatorio	AU44-000400	AU51-500400
Rotatorio	AU44-000450	AU51-500450



Tornillo no incluido en el envase

Calcinable (POM C)



	RP Ø4.10	WP Ø5.10
Antirrotatorio	AU44-E00200	AU51-500200
Rotatorio	AU44-E00250	AU51-500250



Tornillo no incluido en el envase

Pilar Provisional



	RP Ø4.10	WP Ø5.10
TITANIO	Antirrotatorio	AU44-000300 AU51-500300
	Rotatorio	AU44-000350 AU51-500350



Tornillo no incluido en el envase

	RP Ø4.10	WP Ø5.10
PEEK	Antirrotatorio	AU44-000500 -
	Rotatorio	AU44-000550 -



Tornillo no incluido en el envase

Pilar Cementable Recto



	RP Ø4.10	WP Ø5.10
Antirrotatorio	AU44-001320	-
Rotatorio	AU44-001330	-



Tornillo no incluido en el envase

Pilar Cementable Angulado



	RP Ø4.10	WP Ø5.10
15°	H 1.5 mm AU44-001515-15	-
25°	H 2.5 mm AU44-001525-2	-



Tornillo no incluido en el envase

Pilar Multi-Use Recto

Torque m ax: 30 Ncm



	RP Ø4.10	WP Ø5.10
H 0.0 mm	-	-
H 1.0 mm	AU43-501010-CA	-
H 2.0 mm	AU43-501020-CA	-
H 3.0 mm	AU43-501030-CA	-
H 4.0 mm	AU43-501040-CA	-
H 5.0 mm	AU43-501050-CA	-
H 6.0 mm	-	-



Ver componentes Multi-Use en la p gina 46

Pilar Multi-Use Angulado

Torque m ax: 30 Ncm



	RP Ø4.10
17°	H 2.0 mm AU43-501217-2
	H 3.0 mm AU43-501217-3
	H 4.0 mm AU43-501217-4
30°	H 3.0 mm AU43-501230-3
	H 4.0 mm AU43-501230-4
	H 5.0 mm AU43-501230-5



Ver componentes Multi-Use en la p gina 46

Pilar Elitor Recto

Torque m ax: 30 Ncm



	RP Ø4.10	WP Ø5.10
H 0.0 mm	-	-
H 1.0 mm	AU65-00B401	-
H 2.0 mm	AU65-00B402	-
H 3.0 mm	AU65-00B403	-
H 4.0 mm	AU65-00B404	-
H 5.0 mm	AU65-00B405	-
H 6.0 mm	AU65-00B406	-



Ver componentes Elitor en la p gina 47

Pilar Elitor Angulado

Torque m ax: 30 Ncm



	RP Ø4.10
15°	H 1.5 mm AU65-B401A1515
	H 3.0 mm AU65-B401A1530



Ver componentes Elitor en la p gina 47

Tornillo Cl nico Angulable

Torque m ax: 25 Ncm



	RP Ø4.10	WP Ø5.10
Conexi�n	M2	
Tetralobular	AU44-E00050	-
Angled Grip*	AU44-E00060	-



Base Cr-Co Angulable



	RP Ø4.10	WP Ø5.10
Antirrotatorio	AU44-000410	-
Rotatorio	AU44-000460	-



Chimenea Calcinable Angulada



RP Ø4.10	WP Ø5.10
AU67-001701	-



RP Ø4.10	WP Ø5.10
AU67-003001	-



Interfase Angulable



	RP Ø4.10	WP Ø5.10
Antirrotatorio	H 0,5 mm	-
	H 1,5 mm	AU44-000600-15
	H 2,5 mm	AU44-000600-25
	H 3,5 mm	AU44-000600-35
Rotatorio	H 0,5 mm	-
	H 1,5 mm	AU44-000650-15
	H 2,5 mm	AU44-000650-25
	H 3,5 mm	AU44-000650-35



Tornillo no incluido en el envase

Scanbody



RP Ø4.10	WP Ø5.10
AU44-412201	-

Tornillo no incluido en el envase



Réplica Digital



RP Ø4.10	WP Ø5.10
AU44-000010	-



Sistema Transeptelial Estheticone

Pilar Estheticone Recto



	RP Ø4.10	WP Ø5.10
H 1,0 mm	AU43-201010	-
H 2,0 mm	AU43-201020	-
H 3,0 mm	AU43-201030	-

Ver componentes T30r en la página A7



Componentes Estheticone

	RP Ø4.10	WP Ø5.10
Isipón de Cicatrización Titano	AU43-200004	-
Réplica	AU43-200015	-
Calcinable (POM-C) Antirrotatorio	AU43-200200	-
Coping Impresión Cubeta Abierta	AU43-200090	-
Provisional Antirrotatorio	AU43-200300	-

Tornillo Clínico Estheticone Torque máx:25 Nm



	RP Ø4.10	WP Ø5.10
Unigrip	M1.4	
Normal	AU43-E50057	-
DLC	AU43-E50057-N	-

Ver especificaciones en la página 48

	RP Ø4.10	WP Ø5.10
Hexagonal 1.27	M1.4	
Normal	AU43-E50056	-
DLC	AU43-E50056-N	-

Ver especificaciones en la página 48





BTI® Interna®

Plataformas:

RP Ø4.10 / WP Ø5.50

Conexión Tornillo Clínico:

Hexagonal 1,20 / Cuadrada 1,30

Compatible con:

BTI® Interna®

Pilar Cicatrización Torque máx: 20 Ncm



Perfil Emergencia

RP Ø4.10



H 2.0 mm	AU22-412120
H 3.0 mm	AU22-412130
H 4.0 mm	AU22-412140
H 5.0 mm	AU22-412150
H 6.0 mm	AU22-412160
H 8.0 mm	AU22-412180

Coping Impresión



RP Ø4.10

WP Ø5.50

Cubeta Abierta AU22-410090 AU22-550090



Réplica



Ø4.10

Ø5.50

AU22-410015 AU22-550015



Tornillo Clínico Torque máx: 25 Ncm



RP Ø4.10

WP Ø5.50

Hex. 1,20

M1,8

M1,8

Normal

AU22-000054

AU22-000054

DLC

AU22-000054-N

AU22-000054-N



RP Ø4.10

WP Ø5.50

Cuadrada 1,30

M1,8

M1,8

Normal

AU22-000053

AU22-000053

DLC

AU22-000053-N

AU22-000053-N



Ver especificación en la página 48

Ver especificación en la página 48

Calcinable (POM C)



RP Ø4.10

WP Ø5.50

Articulatorio

AU22-410200

AU22-550200

Rotatorio

AU22-410250

AU22-550250



Envío no incluido en el envase

Calcinable con Base Cr-Co



RP Ø4.10

WP Ø5.50

Articulatorio

AU22-410400

AU22-550400

Rotatorio

AU22-410450

AU22-550450



Envío no incluido en el envase

Pilar Multi-Use Recto Torque máx: 30 Nm

	RP Ø4.10	WP Ø5.50
H 0.5 mm	AJ22-411005	-
H 1.0 mm	AJ22-411010	AJ22-551010
H 2.0 mm	AJ22-411020	AJ22-551020
H 3.0 mm	AJ22-411030	AJ22-551030
H 4.0 mm	AJ22-411040	AJ22-551040
H 5.0 mm	AJ22-411050	-



Ver componentes Multi-Use en la página 36

Pilar Multi-Use Angulado Torque máx: 30 Nm

	RP Ø4.10	WP Ø5.50
H 2.0 mm	AJ22-411217-2	-
H 3.0 mm	AJ22-411217-3	-
H 4.0 mm	AJ22-411217-4	-
H 3.0 mm	AJ22-411230-3	-
H 4.0 mm	AJ22-411230-4	-
H 5.0 mm	AJ22-411230-5	-

17°

30°



Ver componentes Multi-Use en la página 36

Pilar Elitor Recto Torque máx: 30 Nm

	RP Ø4.10	WP Ø5.50
H 1.0 mm	AJ65-BT411	-
H 2.0 mm	AJ65-BT412	-
H 3.0 mm	AJ65-BT413	-
H 4.0 mm	AJ65-BT414	-
H 5.0 mm	AJ65-BT415	-
H 6.0 mm	AJ65-BT416	-



Ver componentes Pilar en la página 47

Pilar Provisional

	RP Ø4.10	WP Ø5.50
Antirrotorlo	AJ22-410300	AJ22-550300
Rotatorlo	AJ22-410350	AJ22-550350



Tornillo no incluido en el servicio

Tornillo Clínico Multi-IM Torque máx: 25 Nm

	RP Ø4.10
Hex. 1.20	M1.4
NORMAL	AJ22-000900



Ver funcionamiento en la página 48



Dentsply® Ankylos®

Plataforma:

Ø3.50 / Ø4.50 / Ø5.50 (UNIVERSAL)

Conexión Tornillo Clínico:

Hexagonal 0.90

Compatible con:

Ankylos® C/X

Pilar Cicatrización Torque máx: 20 Ncm



	Ø3.50	
Perfil Emergencia	Ø3.50	Ø4.50



H 2.0 mm	AU27-352120-D35	AU27-352120-D45
H 3.5 mm	AU27-352135-D35	AU27-352135-D45
H 5.0mm	AU27-352150-D35	AU27-352150-D45

Coping Impresión



UNIVERSAL		UNIVERSAL	
Cubeta Abierta	AU27-350090	AU27-350015	



Tornillo Clínico Rotatorio y Escaneado Torque máx: 25 Ncm



UNIVERSAL	
Hexagonal 0.90	M1.8
Normal	AU27-350051



Ver herramientas en la página 48

Calcinable (POM C)



Ø3.50	
Rotatorio	AU28-350250



Tornillo no incluido en el envase

Pilar Provisional Torque máx: 25 Ncm



UNIVERSAL	
Antirrotatorio	AU27-350300
Rotatorio	AU27-350350



Tornillo no incluido en el envase

Pilar Multi-Use Recto Torque máx: 30 Ncm



UNIVERSAL	
H 1.5 mm	AU28-351015
H 2.5 mm	AU28-351025
H 3.5 mm	AU28-351035
H 4.5 mm	AU28-351045
H 5.5 mm	AU28-351055



Ver componentes Multi-Use en la página 46

Pilar Elitor Recto Torque máx: 30 Ncm



UNIVERSAL	
H 2.0 mm	AU65-NCM352
H 3.0 mm	AU65-NCM353
H 4.0 mm	AU65-NCM354
H 5.0 mm	AU65-NCM355
H 6.0 mm	AU65-NCM356



Ver componentes Elitor en la página 47



Megagen® Anyridge®

Plataforma Universal:

Ø3.50 / Ø4.00 / Ø4.50 / Ø5.00 / Ø5.50 / Ø6.00

Conexión Tornillo Clínico:

Hexagonal 1,20

Compatible con:

Megagen® Anyridge®

Pilar Cicatrización Torque máx 20 Ncm



	UNIVERSAL	UNIVERSAL
Perfil Emergencia	Ø5.50	Ø6.50
H 2.0 mm	AU37-352120-55	AU37-352120-65
H 4.0 mm	AU37-352140-55	AU37-352140-65
H 6.0 mm	AU37-352160-55	AU37-352160-65

Coping Impresión



	UNIVERSAL
Cubeta Abierta	AU37-350090



Réplica



	UNIVERSAL
AU37-350015	

Tornillo Clínico Torque máx 25 Ncm



	UNIVERSAL
Hexagonal 1,20	M1,8
Normal	AU37-350054



Ver herramientas en la página 46

Calcinable con Base Cr-Co



	UNIVERSAL
Antirrotatorio	AU37-350400
Rotatorio	AU37-350450



Tornillo no incluido en el ensayo

Calcinable (POM C)



	UNIVERSAL
Antirrotatorio	AU37-350200
Rotatorio	AU37-350250



Tornillo no incluido en el ensayo

Pilar Provisional



	UNIVERSAL
Antirrotatorio	AU37-350300
Rotatorio	AU37-350350



Tornillo no incluido en el ensayo

Pilar Multi-Use Recto Torque máx 30 Ncm



	UNIVERSAL
H 1.5 mm	AU37-351015
H 2.5 mm	AU37-351025
H 3.5 mm	AU37-351035
H 4.5 mm	AU37-351045
H 5.5 mm	AU37-351055



Ver componentes Multi Use en la página 46

Pilar Elitor Recto Torque máx 30 Ncm



	UNIVERSAL
H 1.0 mm	AU65-MA351
H 2.0 mm	AU65-MA352
H 3.0 mm	AU65-MA353
H 4.0 mm	AU65-MA354
H 5.0 mm	AU65-MA355
H 6.0 mm	AU65-MA356



Ver componentes Elitor en la página 47



Mis® Seven®

Plataformas:

Narrow Ø3.30 / Standard Ø3.75 / Wide Ø4.50

Conexión Tornillo Clínico:

Hexagonal 1.27

Compatible con:

Mis Seven / Mis M4

Pilar Cicatrización Torque máx: 20 Ncm



Perfil Emergencia	Narrow Ø3.30	Standard Ø3.75				Wide Ø4.50	
		Ø3.50	Ø4.50	Ø4.80	Ø5.50	Ø4.50	Ø5.50
H 2.0 mm	AU26-332120	AU49-302120	AU49-302120-D45	-	AU49-302120-D55	-	-
H 3.0 mm	AU26-332130	AU49-302130	AU49-302130-D45	AU49-302130-D48	AU49-302130-D55	AU49-402130	AU49-402130-D55
H 4.0 mm	AU26-332140	AU49-302140	AU49-302140-D45	-	-	AU49-402140	AU49-402140-D55
H 5.0 mm	AU26-332150	AU49-302150	AU49-302150-D45	AU49-302150-D48	AU49-302150-D55	AU49-402150	AU49-402150-D55
H 6.0 mm	AU26-332160	-	-	-	-	-	-
H 7.0 mm	-	AU49-302170	AU49-302170-D45	AU49-302170-D48	AU49-302170-D55	-	-

Coping Impresión



	Narrow Ø3.30	Standard Ø3.75	Wide Ø4.50
Cubeta Abierta	AU26-330090	AU49-300090	AU49-400090
Cubeta Cerrada	-	AU49-300080	-



Réplica



	Narrow Ø3.30	Standard Ø3.75	Wide Ø4.50
	AU26-330015	AU49-300015	AU49-400015



Tornillo Clínico Torque máx: 25 Ncm



	Narrow Ø3.30	Standard Ø3.75	Wide Ø4.50
Hex. 1.27	M1.6	1-72 UNF (Ø 1.8MM)	
Normal	AU26-000056	AU49-E30056	AU49-E30056
DLC	-	AU49-E30056-N	AU49-E30056-N



Ver funcionamiento en el capítulo 43

Calcinable con Base Cr-Co



	Narrow Ø3.30	Standard Ø3.75	Wide Ø4.50
Antirrotatorio	AU26-330400	AU49-300400	AU49-400400
Rotatorio	AU26-330450	AU49-300450	AU49-400450



Tornillo no incluido en el envase

Pilar Provisional



	Narrow Ø3.30	Standard Ø3.75	Wide Ø4.50
Antirrotatorio	AU26-330300	AU49-300300	AU49-400300
Rotatorio	AU26-330350	AU49-300350	AU49-400350



Tornillo no incluido en el envase

Calcinable (POM C)



	Narrow Ø3.30	Standard Ø3.75	Wide Ø4.50
Antirrotatorio	AU26-330200	AU49-300200-A	AU49-400200
Rotatorio	AU26-330250	AU49-300250-A	AU49-400250



Tornillo no incluido en el envase

Pilar Cementable Recto Antirrotatorio



	Narrow Ø3.30	Standard Ø3.75	Wide Ø4.50
H 0.0 mm	-	AU49-301320	AU49-401320
H 1.0 mm	-	AU49-301321	AU49-401321
H 2.0 mm	-	AU49-301322	AU49-401322
H 3.0 mm	-	AU49-301323	AU49-401323



Tornillo no incluido en el envase

Pilar Cementable Angulado Antirrotatorio



	Narrow Ø3.30	Standard Ø3.75	Wide Ø4.50
15°	H 1.0 mm	-	AU49-301515-1
	H 2.0 mm	-	AU49-301515-2
	H 3.0 mm	-	AU49-301515-3
25°	H 1.0 mm	-	AU49-301525-1
	H 2.0 mm	-	AU49-301525-2
	H 3.0 mm	-	AU49-301525-3



Tornillo no incluido en el envase

Pilar Multi-Use Recto Torque máx: 30 Ncm



	Narrow Ø3.30	Standard Ø3.75	Wide Ø4.50
H 1.0 mm	AU26-331010	AU49-301010	AU49-401010
H 2.0 mm	AU26-331020	AU49-301020	AU49-401020
H 3.0 mm	AU26-331030	AU49-301030	AU49-401030
H 4.0 mm	AU26-331040	AU49-301040	AU49-401040
H 5.0 mm	-	AU49-301050	AU49-401050



Ver componentes Multi-Use en la página 46

Pilar Multi-Use Angulado Torque máx: 30 Ncm



	Standard Ø3.75	Wide Ø4.50	
17°	H 2.0 mm	AU49-301217	AU49-401217-2
	H 3.0 mm	AU49-301217-3	AU49-401217-3
	H 4.0 mm	AU49-301217-4	AU49-401217-4
30°	H 4.0 mm	AU49-301230	AU49-401230-4
	H 5.0 mm	AU49-301230-5	AU49-401230-5
	H 6.0 mm	AU49-301230-6	AU49-401230-6



Ver componentes Multi-Use en la página 46

Pilar Elitor Recto Torque máx: 30 Ncm



	Narrow Ø3.30	Standard Ø3.75	Wide Ø4.50
H 0.0 mm	-	AU65-PA350	AU65-PA450
H 1.0 mm	AU65-MIS331	AU65-PA351	AU65-PA451
H 2.0 mm	AU65-MIS332	AU65-PA352	AU65-PA452
H 3.0 mm	AU65-MIS333	AU65-PA353	AU65-PA453
H 4.0 mm	AU65-MIS334	AU65-PA354	AU65-PA454
H 5.0 mm	AU65-MIS335	AU65-PA355	AU65-PA455
H 6.0 mm	AU65-MIS336	AU65-PA356	AU65-PA456



Ver componentes Elitor en la página 47

Pilar Elitor Angulado Torque máx: 30 Ncm



	Standard Ø3.75	
15°	H 1.5 mm	AU65-PA35A1515
	H 3.0 mm	AU65-PA35A1530



Ver componentes Elitor en la página 47

Base Cr-Co Angulable



	Narrow Ø3.30	Standard Ø3.75	Wide Ø4.50
Antirrotatorio	-	AU49-300410	AU49-400410
Rotatorio	-	AU49-300460	AU49-400460



Tornillo no incluido en el envase.

Tornillo Clínico Angulable Torque máx: 25 Ncm



	Narrow Ø3.30	Standard Ø3.75	Wide Ø4.50
Conexión			
Tetralobular	-	AU49-E30050	AU49-E30050
Angled Grip®	-	AU49-E30060	AU49-E30060



Ver herramientas en la página 48

Chimenea Calcinable Angulada



	Standard Ø3.75	Wide Ø4.50
17°	AU67-001701	AU67-001701
30°	AU67-003001	AU67-003001



Interfases Angulables



	Standard Ø3.75	Wide Ø4.50	
Antirrotatorio	H 0.5 mm	AU49-300600-05	AU49-400600-05
	H 1.5 mm	AU49-300600-15	-
	H 3.0 mm	AU49-300600-30	-
Rotatorio	H 0.5 mm	AU49-300650-05	AU49-400650-05
	H 1.5 mm	AU49-300650-15	-
	H 3.0 mm	AU49-300650-30	-



Tornillo no incluido en el envase

Scanbody



	Narrow Ø3.30	Standard Ø3.75	Wide Ø4.50
-	-	AU49-302201	AU49-402201



Tornillo no incluido en el envase

Réplica Digital



	Narrow Ø3.30	Standard Ø3.75	Wide Ø4.50
-	-	AU49-300010	AU49-400010





Neodent® GM

Plataforma:

Ø3.50 (Plataforma Única)

Conexión Tornillo Clínico:

NEO

Compatible con:

Neodent GM®

Pilar Cicatrización Torque máx: 20 Ncm



	Ø3.50	
Perfil Emergencia	Ø3.50	Ø4.50
H 2.0 mm	AU35-352120-35	AU35-352120-45
H 3.5 mm	AU35-352135-35	AU35-352135-45
H 5.0 mm	AU35-352150-35	AU35-352150-45

Coping Impresión



	Ø3.50
Cubeta Abierta	AU35-350090



Tornillo Clínico Torque máx: 25 Ncm



NEO	Ø3.50
Normal	AU35-350058
DLC	-



Réplica



Ø3.50
AU35-350015



Ver herramientas en la página 48

Calcinable (POM C)



	Ø3.50
Antirrotatorio	AU35-350200
Rotatorio	AU35-350250



Tornillo no incluido en el envase

Calcinable con Base Cr-Co



	Ø3.50
Antirrotatorio	AU35-350400
Rotatorio	AU35-350450



Tornillo no incluido en el envase

Pilar Multi-Use Recto Torque máx: 30 Ncm



	Ø3.50
H 0.8 mm	AU35-351008
H 1.5 mm	AU35-351015
H 2.5 mm	AU35-351025
H 3.5 mm	AU35-351035
H 4.5 mm	AU35-351045
H 5.5 mm	AU35-351055



Ver componentes Multi-Use en la página 46

Pilar Multi-Use Angulado Torque máx: 30 Ncm



	Ø3.50	
17°	H 2.5 mm	AU35-351217-25
	H 3.5 mm	AU35-351217-35
30°	H 3.5 mm	AU35-351230-35
	H 4.5 mm	AU35-351230-45



Ver componentes Multi-Use en la página 46

Pilar Elitor Recto Torque máx: 30 Ncm



	Ø3.50
H 1.0 mm	AU65-GM351
H 2.0 mm	AU65-GM352
H 3.0 mm	AU65-GM353
H 4.0 mm	AU65-GM354
H 5.0 mm	AU65-GM355
H 6.0 mm	AU65-GM356



Pilar Provisional



	Ø3.50
Antirrotatorio	AU35-350300
Rotatorio	AU35-350350



Tornillo no incluido en el envase



Neodent® CM

Plataforma:
03.50 / 04.50 / 05.50 (UNIVERSAL)

Conexión Tornillo Clínico:
Hexagonal 0.90

Compatible con:
Neodent CM®

Pilar Cicatrización Torque máx: 20 Ncm



UNIVERSAL

Perfil Emergencia

03.50

04.50



H	AU28-352120-D35	AU28-352120-D45
2.0 mm		
3.5 mm	AU28-352135-D35	AU28-352135-D45
5.0 mm	AU28-352150-D35	AU28-352150-D45

Coping Impresión



UNIVERSAL

Cubeta Abierta AU28-350090



Réplica



UNIVERSAL

AU28-350015



Tornillo Clínico

Torque máx: 25 Ncm



UNIVERSAL

Hex. 0.9 M1.8

Normal AU28-350051



Ver componentes en la página 46

Pilar Provisional

Torque máx: 25 Ncm



UNIVERSAL

Antirrotatorio AU28-350300

Rotatorio AU27-350350



Tornillo no incluido en el envío

Calcinable (POM C)



UNIVERSAL

Antirrotatorio	AU28-350200
Rotatorio	AU28-350250



Tornillo no incluido en el envío

Pilar Elitor Recto Torque máx: 30 Ncm



UNIVERSAL

H 2.0 mm	AU65-NCM352
H 3.0 mm	AU65-NCM353
H 4.0 mm	AU65-NCM354
H 5.0 mm	AU65-NCM355
H 6.0 mm	AU65-NCM356



Ver componentes Elitor en la página 47

Pilar Multi-Use Recto Torque máx: 30 Ncm



UNIVERSAL

H 1.5 mm	AU28-351015
H 2.5 mm	AU28-351025
H 3.5 mm	AU28-351035
H 4.5 mm	AU28-351045
H 5.5 mm	AU28-351055



Ver componentes Multi-Use en la página 46

Pilar Multi-Use Angulado Torque máx: 30 Ncm



UNIVERSAL

17°	H 2.5 mm	AU28-351217-25
	H 3.5 mm	AU28-351217-35
30°	H 3.5 mm	AU28-351230-35
	H 4.5 mm	AU28-351230-45



Ver componentes Multi-Use en la página 46

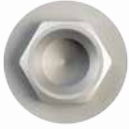

Nobel Biocare® Brånemark System®

Plataformas:

NP Ø3.5 / RP Ø4.1 / WP Ø5.1

Conexión Tornillo Clínico:

Unigrip® / Hexagonal 1.20 / Hexagonal 1.25 / Cuadrada 1.30

Compatible con:

Nobel Biocare Brånemark® / Eckerman® / Phibo-DefconTSH® (S3, S4) / Avinent® EC (4.1, 5.1) / BTI EXTERNA 4.1

Pilar Cicatrización Torque máx: 20 Ncm



Perfil Emergencia	NP Ø3.50		RP Ø4.10		WP Ø5.10	
	Ø3.50	Ø4.50	Ø4.1	Ø5.50	Ø5.1	Ø6.0
H 2.0 mm	-	-	AU44-002120	AU44-002120-50	-	-
H 3.0 mm	AU44-332130	AU44-332130-D45	AU44-002130	AU44-002130-50	AU44-502130	AU44-502130-D60
H 4.0 mm	-	-	AU44-002140	AU44-002140-50	-	-
H 5.0 mm	AU44-332150	AU44-332150-D45	AU44-002150	AU44-002150-50	AU44-502150	AU44-502150-D60

Coping Impresión



Réplica



	NP Ø3.50	RP Ø4.10	WP Ø5.10
Cubeta Abierta	AU44-330090	AU44-000090	AU44-500090
Cubeta Cerrada	-	AU44-000080	-
1.20	-	AU44-000190	-



	NP Ø3.50	RP Ø4.10	WP Ø5.10
	AU44-330015	AU44-000015	AU44-500015



Tornillo Clínico Torque máx:25 Ncm



	NP Ø3.50	RP Ø4.10	WP Ø5.10
Unigrip	M1.6	M2	M2.5
Normal	AU44-330057	AU44-E00057	AU44-500057
DLC	AU44-330057-N	AU44-E00057-N	AU44-500057-N
As. Plano	-	AU44-E00157	-
	NP Ø3.50	RP Ø4.10	WP Ø5.10
Hexagonal 1.20	M1.6	M2	M2.5
Normal	-	AU44-E00054	AU44-500054
DLC	-	AU44-E00054-N	AU44-500054-N

	NP Ø3.50	RP Ø4.10	WP Ø5.10
Hexagonal 1.25	M1.6	M2	M2.5
Normal	-	AU44-E00052	-
DLC	-	AU44-E00052-N	-
	NP Ø3.50	RP Ø4.10	WP Ø5.10
Cuadrado 1.30	M1.6	M2	M2.5
Normal	-	AU44-E00053	-
DLC	-	AU44-E00053-N	-



Ver herramientas en la página 48

Calcinable (POM C)

	NP Ø3.50	RP Ø4.10	WP Ø5.10
Antirrotatorio	AJ44-330200	AJ44-E00200	AJ44-500200
Rotatorio	AJ44-330250	AJ44-E00250	AJ44-500250



Ejemplo no incluido en el paquete

Calcinable con Base Cr-Co

	NP Ø3.50	RP Ø4.10	WP Ø5.10
Antirrotatorio	AJ44-330500	AJ44-000400	AJ44-500400
Rotatorio	AJ44-330550	AJ44-000450	AJ44-500450



Ejemplo no incluido en el paquete

Pilar Provisional

	NP Ø3.50	RP Ø4.10	WP Ø5.10
TITANIO	Antirrotatorio	AJ44-330300	AJ44-000300
	Rotatorio	AJ44-330350	AJ44-000350



Ejemplo no incluido en el paquete

	NP Ø3.50	RP Ø4.10	WP Ø5.10
PEEK	Antirrotatorio	-	AJ44-000500
	Rotatorio	-	AJ44-000550



Ejemplo no incluido en el paquete

Pilar Cementable Recto

	Ø3.50	Ø4.10	Ø5.10
Antirrotatorio	AJ44-331320	AJ44-001320	-
Rotatorio	AJ44-331330	AJ44-001330	-



Ejemplo no incluido en el paquete

Pilar Cementable Angulado

		Ø3.50	Ø4.10	Ø5.10
15°	H 1.5 mm	AJ44-331515-15	AJ44-001515-15	AJ44-501515-15
	H 2.0 mm	-	AJ44-001525-2	-



Ejemplo no incluido en el paquete

Pilar Multi-Use Recto Torque máx: 30 Nm

	NP Ø3.50	RP Ø4.10	WP Ø5.10
H 1.0 mm	AJ43-351010	AJ43-501010-CA	AJ43-601010
H 2.0 mm	AJ43-351020	AJ43-501020-CA	AJ43-601020
H 3.0 mm	AJ43-351030	AJ43-501030-CA	AJ43-601030
H 4.0 mm	-	AJ43-501040-CA	-
H 5.0 mm	-	AJ43-501050-CA	-



Ver componentes Multi-Use en la página 46

Pilar Multi-Use Angulado Torque máx: 30 Nm

		NP Ø3.50	RP Ø4.10
17°	H 2.0 mm	AJ43-351217-2	AJ43-501217-2
	H 3.0 mm	AJ43-351217-3	AJ43-501217-3
	H 4.0 mm	AJ43-351217-4	AJ43-501217-4
30°	H 3.0 mm	AJ43-351230-3	AJ43-501230-3
	H 4.0 mm	AJ43-351230-4	AJ43-501230-4
	H 6.0 mm	-	AJ43-501230-5



Ver componentes Multi-Use en la página 46

Pilar Elitor Recto Torque máx: 30 Nm

	NP Ø3.50	RP Ø4.10	WP Ø5.10
H 1.0 mm	AJ65-00B331	AJ65-00B401	AJ65-00B501
H 2.0 mm	AJ65-00B332	AJ65-00B402	AJ65-00B502
H 3.0 mm	AJ65-00B333	AJ65-00B403	AJ65-00B503
H 4.0 mm	AJ65-00B334	AJ65-00B404	AJ65-00B504
H 5.0 mm	AJ65-00B335	AJ65-00B405	AJ65-00B505
H 6.0 mm	-	AJ65-00B406	-



Ver componentes Elitor en la página 47

Pilar Elitor Angulado Torque máx: 30 Nm

		RP Ø4.10
15°	H 1.0 mm	AJ65-B401A1515
	H 2.0 mm	AJ65-B401A1530



Ver componentes Elitor en la página 47

Tornillo Clínico Angulable Torque máx: 25 Nm

	NP Ø3.50	RP Ø4.10	WP Ø5.10
Conexión	M1.6	M2	M2.5
Tetralobular	AJ44-330050	AJ44-E00050	-
Angled Grip®	-	AJ44-E00060	-



Ver componentes en la página 48

Base Cr-Co Angulable

	NP Ø3.50	RP Ø4.10	WP Ø5.10
Antirrotatorio	AJ44-330410	AJ44-000410	-
Rotatorio	AJ44-330460	AJ44-000460	-



Chimenea Calcinable Angulada



NP Ø3.50	RP Ø4.10	WP Ø5.10
AU67-001701	AU67-001701	-



NP Ø3.50	RP Ø4.10	WP Ø5.10
AU67-003001	AU67-003001	-



Interfase Angulable



	NP Ø3.50	RP Ø4.10	
Antirrotatorio	H 0.5 mm	AU44-330600-05	-
	H 1.5 mm	-	AU44-000600-15
	H 2.5 mm	-	AU44-000600-25
Rotatorio	H 3.5 mm	-	AU44-000600-35
	H 0.5 mm	AU44-330650-05	-
	H 1.5 mm	-	AU44-000650-15
H 2.5 mm	-	AU44-000650-25	
H 3.5 mm	-	AU44-000650-35	



Tornillo no incluido en el envase

Scanbody



NP Ø3.50	RP Ø4.10	WP Ø5.10
AU44-332201	AU44-412201	-

Tornillo no incluido en el envase



Réplica Digital



NP Ø3.50	RP Ø4.10	WP Ø5.10
AU44-330010	AU44-000010	-



Sistema Transepitelial Estheticone

Pilar Estheticone Recto



	NP Ø3.50	RP Ø4.10	WP Ø5.10
H 1.0 mm	-	AU43-201010	-
H 2.0 mm	-	AU43-201020	-
H 3.0 mm	-	AU43-201030	-



Componentes Estheticone

	RP Ø4.10
Tapón de Cicatrización Titanio	CE 0051 AU43-200004
Réplica	CE AU43-200015
Calcinable (POM-C) Antirrotatorio	CE AU43-200200
Coping de Impresión Cubeta Abierta	CE AU43-200090
Provisional Antirrotatorio	CE 0051 AU43-200300

Tornillo Clínico Estheticone Torque máx:25 Ncm



	NP Ø3.50	RP Ø4.10	WP Ø5.10
Unigrip	M1.4		
	Normal	-	AU43-E50057
DLC	-	AU43-E50057-N	-

Hexagonal 1.27

	NP Ø3.50	RP Ø4.10	WP Ø5.10
Hexagonal 1.27	M1.4		
	Normal	-	AU43-E50056
DLC	-	AU43-500056-N	-



Ver herramientas en la página 48



Nobel Replace[®] Select

Plataforma:

NP Ø3.50 / RP Ø4.30 / WP Ø5.00

Conexión Tornillo Clínico:

Unigrip

Compatible con:

Nobel Biocare[®] Select Replace[®] y otros.

Coping Impresión

	NP Ø3.50	RP Ø4.30	WP Ø5.00
Cubeta Abierta	AU54-350090	AU54-430090	AU54-500090



Réplica

	NP Ø3.50	RP Ø4.30	WP Ø5.00
	AU54-350015	AU54-430015	AU54-500015



Tornillo Clínico Torque máx:25 Ncm

	NP Ø3.50	RP Ø4.30	WP Ø5.00
Unigrip[®]	M 1.8	M 2	M 2
Normal	AU54-350057	AU54-430057	AU54-430057
DLC	AU54-350057-N	AU54-430057-N	AU54-430057-N



Ver herramientas en la página 48

Calcinable (POM C)

	NP Ø3.50	RP Ø4.30	WP Ø5.00
Antirrotatorio	AU54-350200-B	AU54-430200-B	AU54-500200-B
Rotatorio	AU54-350250-B	AU54-430250-B	AU54-500250-B



Tornillo no incluido en el envase

Calcinable con Base Cr-Co

	NP Ø3.50	RP Ø4.30	WP Ø5.00
Antirrotatorio	AU54-350400	AU54-430400	AU54-500400
Rotatorio	AU54-350450	AU54-430450	AU54-500450



Tornillo no incluido en el envase

Pilar Provisional

	NP Ø3.50	RP Ø4.30	WP Ø5.00
Antirrotatorio	AU54-350300	AU54-430300	AU54-500300
Rotatorio	AU54-350350	AU54-430350	AU54-500350



Tornillo no incluido en el envase

Pilar Multi-Use Recto Torque máx: 30 Ncm

	NP Ø3.50	RP Ø4.30	WP Ø5.00
H 1.0 mm	AU54-351010	AU54-431010	AU54-501010
H 2.0 mm	AU54-351020	AU54-431020	AU54-501020
H 3.0 mm	AU54-351030	AU54-431030	AU54-501030
H 4.0 mm	-	AU54-431040	-
H 5.0 mm	-	AU54-431050	-



Ver componentes Multi-Use en la página 46

Pilar Multi-Use Angulado Torque máx: 30 Ncm

	NP Ø3.50	RP Ø4.30
17°	H 2.0 mm	AU54-351217 AU54-431217-2
	H 3.0 mm	AU54-351217-3 AU54-431217-3
	H 4.0 mm	- AU54-431217-4
30°	H 4.0 mm	- AU54-431230-4
	H 5.0 mm	- AU54-431230-5



Ver componentes Multi-Use en la página 46

Pilar Elitor Recto Torque m_áx: 30 Ncm

	NP Ø3.50	RP Ø4.30	WP Ø5.00
H 0.0 mm	AU65-SRS350	AU65-SRS430	-
H 1.0 mm	AU65-SRS351	AU65-SRS431	AU65-SRS501
H 2.0 mm	AU65-SRS352	AU65-SRS432	AU65-SRS502
H 3.0 mm	AU65-SRS353	AU65-SRS433	AU65-SRS503
H 4.0 mm	AU65-SRS354	AU65-SRS434	AU65-SRS504
H 5.0 mm	AU65-SRS355	AU65-SRS435	AU65-SRS505
H 6.0 mm	AU65-SRS356	AU65-SRS436	-



Ver componentes Elitor en la página 47

Scanbody

NP Ø3.50	RP Ø4.30	WP Ø5.00
AU54-352201	AU54-432201	AU54-502201



Tornillo no incluido en el envase

Réplica Digital

NP Ø3.50	RP Ø4.30	WP Ø5.00
AU54-350010	AU54-430010	AU54-500010

**Tornillo Clínico Angulable** Torque m_áx: 25 Ncm

	NP Ø3.50	RP Ø4.30	WP Ø5.00
Conexión	M1.8	M2	M2
Tetralobular	AU54-350050	AU54-430050	AU54-430050



Ver herramientas en la página 48

Base Cr-Co Angulable

	NP Ø3.50	RP Ø4.30	WP Ø5.00
Antirrotatorio	AU54-350410	AU54-430410	AU54-500410
Rotatorio	AU54-350460	AU54-430460	AU54-500460



Tornillo no incluido en el envase.

Interfases Angulables

	Ø3.3	Ø3.8	Ø4.25
Antirrotatorio	H 0.5 mm AU54-350600-05	AU54-430600-05	AU54-500600-05
Rotatorio	H 0.5 mm AU54-350650-05	AU54-430650-05	AU54-500650-05



Tornillo no incluido en el envase

Chimenea Calcinable Angulada

	NP Ø3.50	RP Ø4.30	WP Ø5.00
17°	AU67-001701	AU67-001701	AU67-001701
30°	AU67-003001	AU67-003001	AU67-003001





Nobel Biocare® Nobel Active®

Plataformas:

MiP Ø3.0 / NP Ø3.50 / RP Ø4.30

Conexión Tornillo Clínico:

Unigrip®

Compatible con:

Nobel Biocare® Nobel Active® y otros.

Pilar Cicatrización Torque máx: 20 Ncm



	MiP Ø3.00	NP Ø3.50		RP Ø4.30	
Perfil Emergencia	Ø3.60	Ø3.60	Ø5.00	Ø3.90	Ø5.00
H 3.0 mm	AU25-302130	AU25-352130	AU25-352130-D50	AU25-432130	AU25-432130-D50
H 5.0 mm	AU25-302150	AU25-352150	AU25-352150-D50	AU25-432150	AU25-432150-D50
H 7.0 mm	AU25-302170	AU25-352170	AU25-352170-D50	AU25-432170	AU25-432170-D50

Coping Impresión



	MiP Ø3.00	NP Ø3.50	RP Ø4.30
Cubeta Abierta	AU25-300090	AU25-350090	AU25-430090



Réplica



	MiP Ø3.00	NP Ø3.50	RP Ø4.30
	AU25-300015	AU25-350015	AU25-430015



Tornillo Clínico Torque máx:25 Ncm



	MiP Ø3.00	NP Ø3.50	RP Ø4.30
Unigrip®	M1.4	M1.6	M2
Normal	AU25-300057	AU25-350057	AU25-430057
DLC	AU25-300057-N	AU25-350057-N	AU25-430057-N



Pilar Provisional



	MiP Ø3.00	NP Ø3.50	RP Ø4.30
Antirrotatorio	AU25-300300	AU25-350300	AU25-430300
Rotatorio	AU25-300350	AU25-350350	AU25-430350



Tornillo no incluido en el envase

Ver herramientas en la página 48

Calcinable con Base Cr-Co



	MiP Ø3.00	NP Ø3.50	RP Ø4.30
Antirrotatorio	AU25-300400	AU25-350400	AU25-430400
Rotatorio	AU25-300450	AU25-350450	AU25-430450



Tornillo no incluido en el envase

Calcinable (POM C)



	MiP Ø3.00	NP Ø3.50	RP Ø4.30
Antirrotatorio	AU25-300200	AU25-350200	AU25-430200
Rotatorio	AU25-300250	AU25-350250	AU25-430250



Tornillo no incluido en el envase

Pilar Cementable Recto Torque máx: 30 Ncm

	MiP Ø3.00	NP Ø3.50	RP Ø4.30
H 1.5 mm	-	AU25-351321	-
H 2.5 mm	-	AU25-351322	-
H 3.5 mm	-	AU25-351323	-
H 4.5 mm	-	AU25-351324	-
H 5.5 mm	-	AU25-351325	-
H 6.5 mm	-	AU25-351326	-



Tornillo no incluido en el envase

Pilar Cementable Angulado Torque máx: 30 Ncm

		NP Ø3.50
15°	H 1.0 mm	AU25-351515-1
	H 2.0 mm	AU25-351515-2
	H 3.0 mm	AU25-351515-3
25°	H 1.0 mm	AU25-351525-1
	H 2.0 mm	AU25-351525-2
	H 3.0 mm	AU25-351525-3



Tornillo no incluido en el envase

Pilar Multi-Use Recto Torque máx: 30 Ncm

	MiP Ø3.00	NP Ø3.50	RP Ø4.30
H 1.5 mm	-	AU25-351015	AU25-431015
H 2.5 mm	-	AU25-351025	AU25-431025
H 3.5 mm	-	AU25-351035	AU25-431035
H 4.5 mm	-	AU25-351045	AU25-431045
H 5.5 mm	-	AU25-351055	AU25-431055
H 6.5 mm	-	AU25-351065	AU25-431065



Ver componentes Multi-Use en la página 46

Pilar Multi-Use Angulado Torque máx: 30 Ncm

		NP Ø3.50	RP Ø4.30
17°	H 2.5 mm	AU25-351217-25	AU25-431217-25
	H 3.5 mm	AU25-351217-35	AU25-431217-35
30°	H 3.5 mm	AU25-351230-35	AU25-431230-35
	H 4.5 mm	AU25-351230-45	AU25-431230-45



Ver componentes Multi-Use en la página 46

Pilar Elitor Recto Torque máx: 30 Ncm

	MiP Ø3.00	NP Ø3.50	RP Ø4.30
H 1.0 mm	-	AU65-NA351	AU65-NA451
H 2.0 mm	-	AU65-NA352	AU65-NA452
H 3.0 mm	-	AU65-NA353	AU65-NA453
H 4.0 mm	-	AU65-NA354	AU65-NA454
H 5.0 mm	-	AU65-NA355	AU65-NA455
H 6.0 mm	-	AU65-NA356	AU65-NA456



Ver componentes Elitor en la página 47

Scanbody

MiP Ø3.00	NP Ø3.50	RP Ø4.30
AU25-302201	AU25-352201	AU25-432201
	AU25-352202 (Largo)	



Tornillo no incluido en el envase

Réplica Digital

MiP Ø3.00	NP Ø3.50	RP Ø4.30
AU25-300010	AU25-350010	AU25-430010

**Tornillo Clínico Angulable** Torque máx: 25 Ncm

	MiP Ø3.00	NP Ø3.50	RP Ø4.30
		M1.6	M2
Tetralobular	-	AU25-350050	AU25-430050
Angled Grip®	-	AU25-350060	AU25-430060



Ver herramientas en la página 48

Base Cr-Co Angulable

	MiP Ø3.00	NP Ø3.50	RP Ø4.30
Antirrotatorio	-	AU25-350410	AU25-430410
Rotatorio	-	AU25-350460	AU25-430460



Tornillo no incluido en el envase.

Chimenea Calcinable Angulada

	MiP Ø3.00	NP Ø3.50	RP Ø4.30
	-	AU67-001701	AU67-001701



	NP Ø3.50	RP Ø4.10	WP Ø5.10
	-	AU67-003001	AU67-003001

**Interfase Angulable**

		MiP Ø3.00	NP Ø3.50	RP Ø4.30
Antirrotatorio	H 1.5 mm	AU25-300600-15	AU25-350600-15	AU25-430600-15
	H 2.5 mm	-	AU25-350600-25	-
	H 3.5 mm	-	AU25-350600-35	-
Rotatorio	H 1.5 mm	AU25-300650-15	AU25-350650-15	AU25-430650-15
	H 2.5 mm	-	AU25-350650-25	-
	H 3.5 mm	-	AU25-350650-35	-



Tornillo no incluido en el envase



Osstem Implant®

Plataforma:

RP Ø4.00/ Ø4.50 / Ø5.50

Conexión Tornillo Clínico:

Hexagonal 1.20

Compatible con:

Osstem Implant®

Pilar Cicatrización Torque máx: 20 Ncm



UNIVERSAL

Perfil Emergencia

Ø5.50

Ø6.50



H 2.0 mm

AU23-402120-55

AU23-402120-65

H 4.0 mm

AU23-402140-55

AU23-402140-65

H 6.0 mm

AU23-402160-55

AU23-402160-65

Réplica



Ø4.00 / Ø4.50/ Ø5.50

AU23-400015



Coping Impresión



UNIVERSAL

Cubeta Abierta

AU23-400090



Calcinable con Base Cr-Co



Ø4.00 / Ø4.50/ Ø5.50

Antirrotatorio

AU23-400400

Rotatorio

AU23-40450



Tornillo no incluido en el envase

Tornillo Clínico Torque máx:25 Ncm



Ø4.00 / Ø4.50/ Ø5.50

Hex. 1.20

M2

Normal

AU23-400054

Ver herramientas en la página 48



Calcinable (POM C)



Ø4.00 / Ø4.50/ Ø5.50

Antirrotatorio

AU23-400200

Rotatorio

AU23-400250



Tornillo no incluido en el envase

Pilar Multi-Use Recto Torque máx: 30 Ncm



Ø4.00 / Ø4.50/ Ø5.50

H 1.5 mm

AU23-401015

H 2.5 mm

AU23-401025

H 3.5 mm

AU23-401035

H 4.5 mm

AU23-401045

H 5.5 mm

AU23-401055



Ver componentes Multi-Use en pag.-

Pilar Multi-Use Angulado Torque máx: 30 Ncm



Ø4.00 / Ø4.50/ Ø5.50

17°

H 2.5 mm

AU23-401217-25

H 3.5 mm

AU23-401217-35

30°

H 3.5 mm

AU23-401230-35

H 4.5 mm

AU23-401230-45



Ver componentes Multi-Use en la página 46

Pilar Elitor Recto Torque máx: 30 Ncm



Ø4.00 / Ø4.50/ Ø5.50

H 1.0 mm

AU65-OSS401

H 2.0 mm

AU65-OSS402

H 3.0 mm

AU65-OSS403

H 4.0 mm

AU65-OSS404

H 5.0 mm

AU65-OSS405



Ver componentes Elitor en la página 47

Pilar Provisional



Ø4.00 / Ø4.50/ Ø5.50

Antirrotatorio

AU23-400300

Rotatorio

AU23-400350



Chimenea Calcinable Angulada



Ø4.00 / Ø4.50/ Ø5.50

AU67-001701



Ø4.00 / Ø4.50/ Ø5.50

AU67-003001





Straumann® Bone Level

Plataformas:
NC Ø3.3 / RC Ø4.1

Conexión Tornillo Clínico:
Torx

Compatible con:
Straumann® Bone Level® y otros.

Pilar Cicatrización Torque máx: 20 Nm



Perfil Emergencia	NC Ø3.30		RC Ø4.10	
	Ø4.00	Ø5.00	Ø6.00	
H 2.0 mm				
H 4.0 mm	AU34-332120	AU34-412120	AU34-412120-D60	
H 4.0 mm	AU34-332140	AU34-412140	AU34-412140-D60	
H 6.0 mm	AU34-332160	AU34-412160	AU34-412160-D60	

Coping Impresión



Réplica



	NC Ø3.30	RC Ø4.10
Cubeta Abierta	AU34-330090	AU34-410090
Cubeta Cerrada	-	-



	NC Ø3.30	RC Ø4.10
	AU34-330015	AU34-410015



Tornillo Clínico Torque máx: 25 Nm



Pilar Provisional



	NC Ø3.30	RC Ø4.10
Torx	M1.6	M1.6
Normal	AU34-330059	AU34-410059
DLC	AU34-330059-N	AU34-410059-N



	NC Ø3.30	RC Ø4.10
Antirrotatorio	AU34-330300	AU34-410300
Rotatorio	AU34-330350	AU34-410350



Tornillo no incluido en el envase

Ver dimensiones en la página 48

Calcinable con Base Cr-Co



Calcinable (POM C)



	NC Ø3.30	RC Ø4.10
Antirrotatorio	AU34-330400	AU34-410400
Rotatorio	AU34-330450	AU34-410450



	NC Ø3.30	RC Ø4.10
Antirrotatorio	AU34-330200	AU34-410200
Rotatorio	AU34-330250	AU34-410250



Tornillo no incluido en el envase

Tornillo no incluido en el envase

Pilar Multi-Use Recto Torque máx: 30 Nm



	NC Ø3.30	RC Ø4.10
H 1.5 mm	AU34-331015	AU34-411015
H 2.5 mm	AU34-331025	AU34-411025
H 3.5 mm	AU34-331035	AU34-411035
H 4.5 mm	AU34-331045	AU34-411045



Ver componentes Multi-Use en la página 46

Pilar Multi-Use Angulado Torque máx: 30 Nm



	NC Ø3.30	RC Ø4.10	
17°	H 2.5 mm	AU34-331217-2	AU34-411217-2
	H 3.5 mm	AU34-331217-3	AU34-411217-3
30°	H 3.5 mm	AU34-331230-3	AU34-411230-3
	H 4.5 mm	AU34-331230-4	AU34-411230-4



Ver componentes Multi-Use en la página 46

Pilar Elitor Recto Torque máx: 30 Nm



	NC Ø3.30	RC Ø4.10
H 1.0 mm	AU65-CF331	AU65-CF401
H 2.0 mm	AU65-CF332	AU65-CF402
H 3.0 mm	AU65-CF333	AU65-CF403
H 4.0 mm	AU65-CF334	AU65-CF404
H 5.0 mm	AU65-CF335	AU65-CF405
H 6.0 mm	AU65-CF336	AU65-CF406



Ver componentes Elitor en la página 47

Scanbody



NC Ø3.30	RC Ø4.10
AU34-332201	AU34-412201



Tornillo no incluido en el envío

Réplica Digital



NC Ø3.30	RC Ø4.10
AU34-330010	AU34-410010



Tornillo Clínico Angulable Torque máx: 25 Nm



	NC Ø3.30	RC Ø4.10
Conexión	M1.6	
Tetralobular	AU34-330050	AU34-330050
Angled Grip®	AU34-330060	-



Ver herramientas en la página 48

Chimenea Calcinable Angulada



	NC Ø3.30	RC Ø4.10
17°	AU67-001701	AU67-001701
30°	AU67-003001	AU67-003001



Interfase



	NC Ø3.30	RC Ø4.10	
Articulación	H 1.5 mm	AU34-330600-15	AU34-410600-15
Rotatorio	H 1.5 mm	AU34-330650-15	AU34-410650-15



Tornillo no incluido con el envío

Base Cr-Co Angulable



	NC Ø3.30	RC Ø4.10
Articulación	AU34-330410	AU34-410410
Rotatorio	AU34-330480	AU34-410480



Tornillo no incluido en el envío

Componentes Sistema SRA



	CE	Ø4.60
Pilar Calcinación Peek	CE	AU34-462100
Coping Impresión Cubeta Abierta	CE	AU34-460090
Réplica	CE	AU34-460015
Pilar Provisional Rotatorio	CE	AU34-460050
Tornillos Torx M1.4	CE	AU34-460099
Calcinable Rotatorio	CE	AU34-460250



Straumann® Tissue Level

Plataformas:

RN Ø4.8 o WN Ø6.50

Conexión Tornillo Clínico:

Torx

Compatible con:

Straumann® Tissue Level® y otros.

Pilar Cicatrización Torque máx: 20 Nm



Perfil Emergencia	RN Ø4.80
	Ø5.5
	
H 2.0 mm	AU33-482120-D55
H 3.0 mm	AU33-482130-D55
H 4.5 mm	AU33-482145-D55

Coping Impresión



	RN Ø4.80	WN Ø6.50
Cubeta Abierta	AU33-480090	AU33-650090



Réplica



RN Ø4.80	WN Ø6.50
AU33-480015	AU33-650015



Tornillo Clínico Torque máx:25 Nm



	RN Ø4.80		WN Ø6.50
	Torx	M2	M2
PARA CALCINABLE (POMC)	Normal	AU33-480059	AU33-480059
	DLC	AU33-480059T	AU33-480059T
PARA CHOCO Y PROVISIONAL	Normal	AU33-480055	AU33-480055
	DLC	AU33-480055T	AU33-480055T



Ver Anotaciones en la página 42

Calcinable (POM C)



	RN Ø4.80	WN Ø6.50
Articulación	AU33-480200	AU33-650200
Rotación	AU33-480250	AU33-650250



Tornillo no incluido en el envío

Calcinable con Base Cr-Co



	RN Ø4.80
Articulación	AU33-480400
Rotación	AU33-480450



Tornillo no incluido en el envío

Pilar Macizo



	RN Ø4.80
H 4.0 mm	AU33-481240
H 5.5 mm	AU33-481255



Tornillo no incluido en el envío

Pilar Macizo con Conexión Llave Ø1.25



	RN Ø4.80
H 4.0 mm	AU33-481440-125
H 5.5 mm	AU33-481455-125
H 7.0 mm	AU33-481470-125



Tornillo no incluido en el envío

Pilar Cementable Recto



RN Ø4.80
AU33-481321



Tornillo no incluido en el envase

Pilar Cementable Angulado



RN Ø4.80
12° AU33-481515-1
30° AU33-481525-1



Tornillo no incluido en el envase

Coping Impresión
Para Pilar Cementable Recto



RN Ø4.80
AU33-481300



Tornillo no incluido en el envase

Calcinable Pick Up
Para Pilar Cementable Recto



RN Ø4.80
Antirrotatorio AU33-501400
Rotatorio AU33-501450



Pilar Multi-Use Recto Torque máx: 30 Nm



RN Ø4.80
H 1.0 mm AU33-481010



Ver componentes Multi-Use en la página 46

Pilar Multi-Use Angulado Torque máx: 30 Nm



RN Ø4.80
12° H 2.5 mm AU33-481217-25
30° H 3.5 mm AU33-481230-35



Ver componentes Multi-Use en la página 46

Pilar Provisional



RN Ø4.80 **WN Ø6.50**
Antirrotatorio AU33-480300 AU33-650300
Rotatorio AU33-480360 AU33-650350



Tornillo no incluido en el envase

Pilar Elitor Recto Torque máx: 30 Nm



RN Ø4.80
H 1.0 mm AU85-001401
H 2.0 mm AU85-001402
H 3.0 mm AU85-001403
H 4.0 mm AU85-001404
H 5.0 mm AU85-001405
H 6.0 mm AU85-001406



Ver componentes Elitor en la página 47

Pilar Elitor Angulado Torque máx: 30 Nm



RN Ø4.80
12° H 1.5 mm AU85-T40A1515



Ver componentes Elitor en la página 47

Tornillo Cícnico Angulable Torque máx: 25 Nm



RN Ø4.80
Conexión M2
Tetralobular AU33-480050
Angled Grip® AU33-480060



Ver herramientas en la página 45

Base Cr-Co Angulable



RN Ø4.80
Antirrotatorio AU33-480410
Rotatorio AU33-480460



Tornillo no incluido en el envase

Chimenea Calcinable Angulada



RN Ø4.80
12° AU67-001701
30° AU67-003001



Interfases Angulables



RN Ø4.80
Antirrotatorio H 0.5 mm AU33-480600-05
Rotatorio H 0.5 mm AU33-480650-05



Tornillo no incluido en el envase

Scanbody



RN Ø4.80
AU33-482201



Tornillo no incluido en el envase

Réplica Digital



RN Ø4.80
AU33-480010



Tornillo no incluido en el envase

Pilar Octa



RN Ø4.80
AU33-500010



Tornillo no incluido en el envase

Componentes Sistema Synocta

Pilar Synocta Conversor



RN Ø4.80

Antirrotatorio AU33-500009

Tornillo no incluido en el envase



Coping Impresión Synocta



RN Ø4.80

AU33-500090



Réplica Sistema Synocta



RN Ø4.80

AU33-500015

Tornillo no incluido en el envase



Tornillo Clínico Sistema Synocta



RN Ø4.80

M2

Normal AU33-E50059

DLC AU33-E50059-N



Calcínable (POM C) Sistema Synocta



RN Ø4.80

Antirrotatorio AU33-500200

Rotatorio AU33-500250

Tornillo no incluido en el envase



Calcínable Base Cr-Co Sistema Synocta



RN Ø4.80

Antirrotatorio AU33-500400

Rotatorio AU33-500450

Tornillo no incluido en el envase



Ver herramientas en la página 48



Sweden Y Martina® Premium Kohno®

Plataformas:
Ø3.30 / Ø3.80 / Ø4.25

Conexión Tornillo Clínico:
Hexagonal 1.27

Compatible con:
Sweden Y Martina® Premium Kohno®

Pilar Cicatrización Torque máx: 20 Ncm



	Ø3.30	Ø3.80
Perfil Emergencia	Ø3.50	Ø4.50
H 2.0 mm	AU17-332120	AU17-382120
H 3.0 mm	AU17-332130	AU17-382130
H 5.0 mm	AU17-332150	AU17-382150
H 7.0 mm	-	AU17-382170



Coping Impresión



	Ø3.30	Ø3.80	Ø4.25
Cubeta Abierta	AU17-330090	AU17-380090	AU17-420090



Réplica



	Ø3.30	Ø3.80	Ø4.25
	AU17-330015	AU17-380015	AU17-420015



Tornillo Clínico Torque máx: 25 Ncm



	Ø3.30	Ø3.80	Ø4.25
Hex. 1.27	M1.8	M1.8	M2
Normal	AU17-330052	AU17-330052	AU17-420052
DLC	AU17-330052-N	AU17-330052-N	AU17-420052-N



Ver herramientas en la página 48

Pilar Provisional



	Ø3.30	Ø3.80	Ø4.25
Antirrotatorio	AU17-330300	AU17-380300	AU17-420300
Rotatorio	AU17-330350	AU17-380350	AU17-420350



Tornillo no incluido en el envase

Calcinable con Base Cr-Co



	Ø3.30	Ø3.80	Ø4.25
Antirrotatorio	AU17-330400	AU17-380400	AU17-420400
Rotatorio	AU17-330450	AU17-380450	AU17-420450



Tornillo no incluido en el envase.

Calcinable (POM C)



	Ø3.30	Ø3.80	Ø4.25
Antirrotatorio	AU17-330200	AU17-380200	AU17-420200
Rotatorio	AU17-330250	AU17-380250	AU17-420250



Tornillo no incluido en el envase

Pilar Multi-Use Recto Torque máx: 30 Ncm



	Ø3.30	Ø3.80	Ø4.25
H 1.0 mm	AU17-331010	AU17-381010	AU17-421010
H 2.0 mm	AU17-331020	AU17-381020	AU17-421020
H 3.0 mm	AU17-331030	AU17-381030	AU17-421030
H 4.0 mm	AU17-331040	AU17-381040	AU17-421040



Ver componentes Multi-Use en la página 46

Pilar Multi-Use Angulado Torque máx: 30 Ncm



	Ø3.3	Ø3.8	Ø4.25
H 2.5 mm	AU17-331217-2	AU17-381217-2	AU17-421217-2
17°	H 3.5 mm	AU17-331217-3	AU17-381217-3
	H 4.5 mm	AU17-331217-4	AU17-381217-4
30°	H 3.5 mm	AU17-331230-3	AU17-381230-3
	H 4.5 mm	AU17-331230-4	AU17-381230-4



Ver componentes Multi-Use en la página 46

Pilar Elitor Recto Torque máx: 30 Ncm

	Ø3.30	Ø3.80	Ø4.25
H 1.0 mm	AU65-PK331	AU65-PK381	AU65-PK4251
H 2.0 mm	AU65-PK332	AU65-PK382	AU65-PK4252
H 3.0 mm	AU65-PK333	AU65-PK383	AU65-PK4253
H 4.0 mm	AU65-PK334	AU65-PK384	AU65-PK4254
H 5.0 mm	-	AU65-PK385	AU65-PK4255
H 6.0 mm	-	-	AU65-PK4256



Ver componentes Elitor en la página 47

Base Cr-Co Angulable

	Ø3.30	Ø3.80	Ø4.25
Antirrotatorio	AU17-330410	AU17-380410	AU17-420410
Rotatorio	AU17-330460	AU17-380460	AU17-420460



Tornillo no incluido en el envase.

Tornillo Clínico Angulable Torque máx: 25 Ncm

	Ø3.30	Ø3.80	Ø4.25
Conexión	M1.8	M1.8	M2
TETRALOBULAR	AU17-330050	AU17-330050	AU17-420050



Ver herramientas en la página 48

Chimenea Calcinable Angulada

	Ø3.30	Ø3.80	Ø4.25
17°	AU67-001701	AU67-001701	AU67-001701
30°	AU67-003001	AU67-003001	AU67-003001

**Interfases Angulables**

	Ø3.30	Ø3.80	Ø4.25
Antirrotatorio	H 0.5 mm AU17-330600-05	AU17-380600-05	AU17-420600-05
Rotatorio	H 0.5 mm AU17-330650-05	AU17-380650-05	AU17-420650-05



Tornillo no incluido en el envase

Réplica Digital

	Ø3.30	Ø3.80	Ø4.25
	AU17-330010	AU17-380010	AU17-420010

**Scanbody**

	Ø3.30	Ø3.80	Ø4.25
	AU17-332201	AU17-382201	AU17-422201



Tornillo no incluido en el envase



Zimmer® Screw Vent®

Plataformas:

XN Ø2.90 / NP Ø3.50 / RP Ø4.50 / WP Ø5.70

Conexión Tornillo Clínico:

Hexagonal 1.27

Compatible con:

Zimmer Dental® Tapered Screw-Vent® / BioHorizons® Tapered Internal, Internal Plus, Tapered Tissue Level y otros.

Pilar Cicatrización Torque màx: 20 Ncm



	Ø2.90	Ø3.50				Ø4.50		Ø5.70
Perfil Emergencia	Ø3.70	Ø3.50	Ø4.50	Ø4.80	Ø5.50	Ø4.50	Ø5.50	Ø6.50
H 1.5 mm	AU49-292115-D37	-	-	-	-	-	-	-
H 2.0 mm	-	AU49-302120	AU49-302120-D45	-	AU49-302120-D55	-	-	-
H 3.0 mm	AU49-292130-D37	AU49-302130	AU49-302130-D45	AU49-302130-D48	AU49-302130-D55	AU49-402130	AU49-402130-D55	AU49-502130
H 4.0 mm	-	AU49-302140	AU49-302140-D45	-	-	AU49-402140	AU49-402140-D55	-
H 4.5 mm	AU49-292145-D37	-	-	-	-	-	-	-
H 5.0 mm	-	AU49-302150	AU49-302150-D45	AU49-302150-D48	AU49-302150-D55	AU49-402150	AU49-402150-D55	AU49-502150
H 7.0 mm	-	AU49-302170	AU49-302170-D45	AU49-302170-D48	AU49-302170-D55	-	-	-

Coping Impresión



	Ø2.90	Ø3.50	Ø4.50	Ø5.70
C. Abierta	AU49-290090	AU49-300090	AU49-400090	AU49-500090
C. Cerrada	-	AU49-300080	-	-



Réplica



	Ø2.90	Ø3.50	Ø4.50	Ø5.70
	AU49-290015	AU49-300015	AU49-400015	AU49-500015



Tornillo Clínico Torque màx:25 Ncm



	Ø2.90	Ø3.50	Ø4.50	Ø5.70
Hex. 1.27	M1.6	1-72 UNF (Ø 1.8MM)		
Normal	AU49-290056	AU49-E30056	AU49-E30056	AU49-E30056
DLC	-	AU49-E30056-N	AU49-E30056-N	AU49-E30056-N



Ver herramientas en la página 48

Calcinable con Base Cr-Co



	Ø2.90	Ø3.50	Ø4.50	Ø5.70
Antirrotatorio	AU49-290400	AU49-300400	AU49-400400	AU49-500400
Rotatorio	-	AU49-300450	AU49-400450	-



Tornillo no incluido en el envase

Pilar Provisional



	Ø2.90	Ø3.50	Ø4.50
Antirrotatorio	AU49-290300	AU49-300300	AU49-400300
Rotatorio	-	AU49-300350	AU49-400350



Tornillo no incluido en el envase

Calcinable (POM C)



	Ø2.90	Ø3.50	Ø4.50	Ø5.70
Antirrotatorio	AU49-290200	AU49-300200-A	AU49-400200	AU49-500200
Rotatorio	-	AU49-300250-A	AU49-400250	AU49-500250



Tornillo no incluido en el envase

Pilar Cementable Recto Antirrotatorio



	Ø3.50	Ø4.50	Ø5.70
H 0.0 mm	AU49-301320	AU49-401320	-
H 1.0 mm	AU49-301321	AU49-401321	-
H 2.0 mm	AU49-301322	AU49-401322	-
H 3.0 mm	AU49-301323	AU49-401323	-



Tornillo no incluido en el envase

Pilar Multi-Use Recto Torque m_áx: 30 Ncm



	Ø3.50	Ø4.50	Ø5.70
H 1.0 mm	AU49-301010	AU49-401010	-
H 2.0 mm	AU49-301020	AU49-401020	-
H 3.0 mm	AU49-301030	AU49-401030	-
H 4.0 mm	AU49-301040	AU49-401040	-
H 5.0 mm	AU49-301050	AU49-401050	-



Ver componentes Multi-Use en la página 46

Pilar Elitor Recto Torque m_áx: 30 Ncm



	Ø2.90	Ø3.50	Ø4.50	Ø5.70
H 0.0 mm	-	AU65-PA350	AU65-PA450	-
H 1.0 mm	AU65-PA291	AU65-PA351	AU65-PA451	AU65-PA501
H 2.0 mm	AU65-PA292	AU65-PA352	AU65-PA452	AU65-PA502
H 3.0 mm	AU65-PA293	AU65-PA353	AU65-PA453	AU65-PA503
H 4.0 mm	AU65-PA294	AU65-PA354	AU65-PA454	AU65-PA504
H 5.0 mm	AU65-PA295	AU65-PA355	AU65-PA455	AU65-PA505
H 6.0 mm	AU65-PA296	AU65-PA356	AU65-PA456	-



Ver componentes Elitor en la página 47

Tornillo Clínico Angulable Torque m_áx: 25 Ncm



Conexión	Ø3.50	Ø4.50
Tetralobular	AU49-E30050	AU49-E30050
Angled Grip®	AU49-E30060	AU49-E30060



Ver herramientas en la página 48

Interfases Angulables



	Ø3.50	Ø4.50
Antirrotatorio	H 0.5 mm	AU49-300600-05 AU49-400600-05
	H 1.5 mm	AU49-300600-15 -
	H 3.0 mm	AU49-300600-30 -
Rotatorio	H 0.5 mm	AU49-300650-05 AU49-400650-05
	H 1.5 mm	AU49-300650-15 -
	H 3.0 mm	AU49-300650-30 -



Tornillo no incluido en el envase

Pilar Cementable Angulado Antirrotatorio



	Ø3.50	Ø4.50	Ø5.70
15°	H 1.0 mm	AU49-301515-1	-
	H 2.0 mm	AU49-301515-2	-
	H 3.0 mm	AU49-301515-3	-
25°	H 1.0 mm	AU49-301525-1	-
	H 2.0 mm	AU49-301525-2	-
	H 3.0 mm	AU49-301525-3	-



Tornillo no incluido en el envase

Pilar Multi-Use Angulado Torque m_áx: 30 Ncm



	Ø3.50	Ø4.50
17°	H 2.0 mm	AU49-301217 AU49-401217-2
	H 3.0 mm	AU49-301217-3 AU49-401217-3
	H 4.0 mm	AU49-301217-4 AU49-401217-4
30°	H 4.0 mm	AU49-301230 AU49-401230-4
	H 5.0 mm	AU49-301230-5 AU49-401230-5
	H 6.0 mm	AU49-301230-6 AU49-401230-6



Ver componentes Multi-Use en la página 46

Pilar Elitor Angulado Torque m_áx: 30 Ncm



	Ø3.50	
15°	H 1.5 mm	AU65-PA35A1515
	H 3.0 mm	AU65-PA35A1530



Ver componentes Elitor en la página 47

Base Cr-Co Angulable



	Ø3.50	Ø4.50
Antirrotatorio	AU49-300410	AU49-400410
Rotatorio	AU49-300460	AU49-400460



Tornillo no incluido en el envase.

Chimenea Calcinable Angulada



	Ø3.50	Ø4.50
17°	AU67-001701	AU67-001701
30°	AU67-003001	AU67-003001



Interfases Angulables



Scanbody



Ø3.50	Ø4.50	Ø5.70
AU49-302201	AU49-402201	-

Tornillo no incluido en el envase

Réplica Digital



Ø3.50	Ø4.50	Ø5.70
AU49-300010	AU49-400010	-



Componentes Multi-Use

Plataforma:

RP Ø4.8 / WP Ø6.5

Conexión Tornillo Clínico:

UNIGRIP® / Hexagonal 1.27

Compatible con:

Nobel Biocare®, Multi-Use.

Coping de Impresión



RP Ø4.8		
C. Abierta	Unigrip	AU43-500090
	Hexagonal 1.27	AU43-5000190
C. Cerrada		AU43-500080



Réplica

RP Ø4.8

WP Ø6.5

AU43-500015

AU43-600015



Tapón Cicatrización Titanio



	RP Ø4.8	WP Ø6.5
Hexagonal 1.27	AU43-000007	-
Unigrip	AU43-000006	-



Tornillo Clínico Torque máx: 25 Ncm



	RP Ø4.80	WP Ø6.50
UNIGRIP	Métrica	M1.4
	Normal	AU43-E50057
	DLC	AU43-E50057-N
HEXAGONAL 1.27	Normal	AU43-E50056
	DLC	AU43-500056-N



Pilar Provisional



	RP Ø4.8	WP Ø6.5
Titanio Rotatorio	AU43-500300	AU43-600300
Peek Rotatorio	AU43-500500	-



Ver herramientas en la página 48

Calcinable (POM C)



	RP Ø4.80	WP Ø6.50
Antirrotatorio	-	-
Rotatorio	AU43-500250	AU43-600250



Tornillo no incluido en el envase

Calcinable con base Cr-Co



	RP Ø4.80	WP Ø6.50
Antirrotatorio	-	-
Rotatorio	AU43-500450	-



Tornillo no incluido en el envase

Tornillo Clínico Ang. Torque máx: 25 Ncm



	RP Ø4.80
	M1.4
Tetralobular	AU43-E50050
Angled Grip®	AU43-500060



Ver herramientas en la página 48

Pilar Elitor Torque máx: 30 Ncm



RP Ø4.80
AU43-654800



Ver Componentes Elitor en la página 47

Base Cr-Co Angulable



	RP Ø4.80
Antirrotatorio	-
Rotatorio	AU43-500460



Ver herramientas en la página 48

Interfases Angulares



	RN Ø4.80
Rotatorio	H 0.5 mm
	AU43-500650-05



Tornillo no incluido en el envase

Réplica Digital



RP Ø4.8
AU43-500010



Scanbody



RP Ø4.8
AU43-502201



Tornillo no incluido en el envase

Componentes Sobredentadura Elitor

Compatible con:

Compatible con: Locator® / Kerator® / Elitor® y otros.



Pilar Elitor Barra



AU65-00BAR



Inserto Calcinable Roscado



AU65-016



Transportador



AU65-011



Coping de Impresión



AU65-012



Réplica



AU65-010



Arandela Espaciadora (Pack 4 uds)



AU65-006/4



**Retenedores
(Pack 4 uds)**



Negro	AU65-000/4
Rojo	AU65-001/4 (1.0 lbs)
Azul	AU65-002/4 (1.5 lbs)
Naranja	AU65-005/4 (2.0 lbs)
Rosa	AU65-003/4 (3.0 lbs)
Verde	AU65-007/4 (4.0 lbs)
Transparente	AU65-004/4 (5.0 lbs)



**Kit de
Procesado**



Cápsula metálica + 5 Retenedores
+ Arandela espaciadora
AU65-009KIT



**Kit de Procesado
Angulado**



Cápsula metálica + 4 Retenedores
+ Arandela espaciadora
AU65-009KITANG



**Herramienta Multifunción
para Elitor**



VDVL-3



**Cápsula Metálica
+ Retención Negra (Pack 4 uds)**



AU65-009/4













Llaves y Herramientas

Llaves Protésicas



	 Hexagonal 0.90	 Hexagonal 1.0	 Hexagonal 1.20	 Hexagonal 1.25	 Hexagonal 1.27	 Hexagonal 1.30	 Torx	 Unigrip
Manual								
Corta (22mm)	AU59-200090-S	AU59-200105	AU59-200130	AU59-200120	AU59-200127-S	AU59-200115	AU59-200173	AU59-200177
Larga (29mm)	AU59-200090-L	AU59-200100	AU59-200135	AU59-200125	AU59-200127-L	AU59-200110	AU59-200174	AU59-200178

	 Hexagonal 1.20	 Hexagonal 1.25	 Hexagonal 1.27	 Unigrip
Carraca Conexión 4x4				
Corta (17mm)	AU59-100130	AU59-100120	AU59-100140	AU59-100150
Larga (21mm)	AU59-100135	AU59-100125	AU59-100145	AU59-100155









	 Hexagonal 0.90	 Hexagonal 1.0	 Hexagonal 1.20	 Hexagonal 1.25	 Hexagonal 1.27	 Hexagonal 1.30	 Hexagonal 1.70	 Torx	 Unigrip	 Neo	 Cuadrada 1.30
Contra-ángulo											
Corta (20mm)	AU58-100205-S	AU58-100111	AU58-100130	AU58-100120	AU58-100117	AU58-100132	AU58-100185	AU58-100174	AU58-100178	AU58-100179	AU58-100133
Larga (25mm)	AU58-100205	AU58-100111-M	AU58-100135	AU58-100125	AU58-100118	AU58-100132-M	AU58-100186	AU58-100174-M	AU58-100178-M	AU58-100179-M	AU58-100133-M
X Larga (35mm)	-	-	AU58-100135-L	AU58-100125-L	AU58-100118-L	-	-	AU58-100174-L	AU58-100178-L	-	-

	 Hexagonal 1.27	 Unigrip
Manual/Carraca Ø 7.0mm		
Corta (22mm)	AU59-200127-S-R	AU59-200177-R
Larga (29mm)	AU59-200127-L-R	AU59-200178-R

Llaves y Herramientas

Llaves Para Pilares Transepiteliales



	 Multi-Use Hex.2.0	 Multi-Use Hex.2.5	 Elitor
Manual			
Corta (22mm)	AU59-200160-S	AU59-200161-S	-
Larga (29mm)	AU59-200160-L	AU59-200161-L	-
	 Multi-Use Hex.2.0	 Multi-Use Hex.2.5	 Elitor
Carraca			
Corta (17mm)	AU59-100160	AU59-100161	AU59-100146
Larga (21mm)	AU59-100160-L	AU59-100161-L	-
	 Multi-Use Hex.2.0	 Multi-Use Hex.2.5	 Elitor
Contra-ángulo			
Corta (20mm)	AU58-100160	AU58-100161	AU58-100146

Llaves Para Tornillos Angulables



	 Angled Grip	 Tetralobular
Contra-ángulo		
Corta (20mm)	AU58-100300	AU58-400100-S
Larga (25mm)	AU58-100300-M	AU58-400200-L
X Larga (35mm)	-	AU58-400300-EL

Llaves Para Tornillos de Osteosíntesis



	 Multi-Use Hex.2.0
Contra-ángulo	
Larga (25mm)	AU58-200100-L

Carracas Dinamométricas



VDIN

CUADRADA 4*4



VDIN2

CONEXIÓN Ø7.0



Kits Protésicos



Contra-ángulo			
Corto	(20mm)	Esterilizable	AU58-100001
Largo	(25mm)	Esterilizable	AU58-100002





Llaves y Herramientas

Mangos y Adaptadores



Adaptador de Contra-Ángulo a Carraca



Straumann Ø7	AU59-100198
Nobel Biocare Ø8	AU59-100199



Mango para llave Contra-Ángulo



Corto	AU58-100190
Largo	AU58-100190-LP



Adaptador de Contra-Ángulo a Carraca Cuadrada 4x4mm



AU59-100194

Kit de Extractores Implantes y Tornillos Coronados



Kit de Extractores No 1, 2, 3, 4 (incluye Adaptador + Extensor + Caja)



AU EXT-IMP KIT-2



Extractor Tornillo Coronado N.1 para Carraca Cuadrada 4x4mm



AU EXT-IMP-1



Extractor Tornillo Coronado N.2 para Carraca Cuadrada 4x4mm



AU EXT-IMP-2



Adaptador Llave Carraca Cuadrada 4x4mm

AU59-100191



Para implantes M 1.6.
Torque máximo 100 Ncm

Extractor Tornillo Coronado N.3 para Carraca Cuadrada 4x4mm



AU EXT-IMP-3



Para implantes M 1.8 - M 2.
Torque máximo 200 Ncm

Extractor Tornillo Coronado N.4 para Carraca Cuadrada 4x4mm



AU EXT-IMP-4



Extensor para Carraca Cuadrada 4x4mm



AU59-100195

Otras Conexiones Disponibles

Hexágono Externo Alto

Compatible con:

Compatible con: Klockner®.

Coping de Impresión

AU10-000090



Réplica

AU10-000015



Tornillo

AU10-000052



Calcinable (POM C)

Antirrotatorio AU10-000200

Rotatorio AU10-000250



Pilar Elitor

H 2.0 mm AU65-KL422

H 3.0 mm AU65-KL423

H 4.0 mm AU65-KL424



Hexágono Externo TSH2

Compatible con:

Phibo® TSH2.

Pilar Elitor Recto

H 1.0 mm AU65-TSH331

H 2.0 mm AU65-TSH332

H 3.0 mm AU65-TSH333

H 4.0 mm AU65-TSH334

H 5.0 mm AU65-TSH335



MIS C1

Compatible con:

Mis C1

Pilar Elitor Recto

SP Ø4.2

H 1.0 mm AU65-MC421

H 2.0 mm AU65-MC422

H 3.0 mm AU65-MC423

H 4.0 mm AU65-MC424

H 5.0 mm AU65-MC425

H 6.0 mm AU65-MC426



Cigomático

(Hexágono externo universal)

Pilar Multi-Use Recto

H 1.0 mm AU43-Z01010

H 2.0 mm AU43-Z01020



Pilar Multi-Use Angulado

H 2.0 mm AU43-501217-2

17° H 3.0 mm AU43-501217-3

H 4.0 mm AU43-501217-4

H 3.0 mm AU43-501230-3

30° H 4.0 mm AU43-501230-4

H 5.0 mm AU43-501230-5



Tornillo Clínico Cigomático

Métrica M2

Normal AU43-501200-Z



Biomateriales

ETGRAFT TCP FOSFATO TRICÁLCICO, 1GR. (FINO O MEDIO)

Biomaterial sintético poroso a base de fosfato tricálcico (B-TCP), desarrollado para la regeneración ósea.

Composición:

99.9% Fosfato Tricálcico (B-TCP).

Referencia	Geometría	Dimensiones	Cantidad
TGR050110P-U	Gránulos	0.5 - 1.0mm	1gr x 1 Unid.
TGR050110P	Gránulos	0.5 - 1.0mm	1gr x 5 Unid.



Distribuidor;



www.eliteabutments.com

info@eliteabutments.com

 **Titanimplant, S.L.**
www.titanimplant.net

C/ General Manso, 28-38, Local 4
08980 Sant Feliu de Llobregat
Barcelona, España.

